



AIR-CELL Insulbreak®

THERMAL BREAK SOLUTION



- 3-in-1 Insulation, thermal break and vapour barrier
- Delivers a R0.20 thermal break solution for steel-framed construction
- Helps achieve a 6-star house energy rating
- Fibre-free, non-allergenic, non-irritant
- Quick and easy to install
- Strong, tough, durable
- Water-resistant and unaffected by moisture
- Anti-bacterial and anti-fungal
- Rodent and insect resistant
- Compliant with AS/NZS 4859.1:2018
- CodeMark-certified for NCC compliance
- Made in Australia



Low Energy –
Low Carbon Buildings

Welcome to Kingspan Insulation

Kingspan Insulation is a market leading manufacturer of innovative ultra-thin flexible insulation products and super high performance rigid insulation products for building fabric and building services applications. Kingspan Insulation is committed to providing the world market with high quality, innovative products supported by technical expertise and customer service which is unsurpassed in the industry.

Kingspan Insulation has a vast product range including optimum performance next generation insulation solution **OPTIM-R™**; super high performance rigid thermoset phenolic **Kooltherm®** insulation; flexible fibre-free reflective insulation **AIR-CELL®**; high performance rigid **Therma™** insulation; and high performance rigid *Kingspan GreenGuard®* insulation*. The extensive range of products is suitable for a variety of applications including:

- pitched roofs;
- flat roofs;
- tapered roofing systems;
- cavity walls;
- solid walls;
- insulated dry lining;
- timber and steel framing;
- externally insulated cladding systems;
- externally insulated render systems;
- floors;
- soffits; and
- ductwork in building services applications

Kingspan Insulation also supplies:

- *Kingspan Thermabate®* Cavity Closer;*
- *Kingspan TEK®* range of structurally insulated panels;*
- the *Kingspan KoolDuct®* System of pre-insulated ducting;
- Pre-insulated plenum boxes;
- *Kingspan nilvent®* - breathable membrane for roofs and walls*

Manufacturing excellence, first class customer service and unrivalled expertise in meeting the needs of the market are just some of the many strengths that Kingspan Insulation offers to designers, engineers and contractors.

**Not currently available in Australia*



Commercial Metal Deck Roof

Typical Design Details



Figure 1 *Kingspan AIR-CELL Insulbreak*® in a metal roof with a raked ceiling

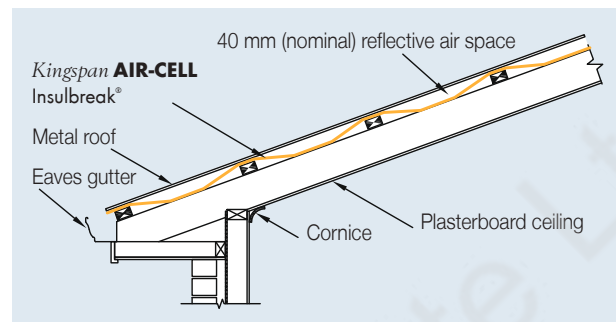

Figure 2 Side elevation of *Kingspan AIR-CELL Insulbreak*® in a metal roof with a raked ceiling

Thermal Performance

NCC 2019 prescribes different methods to determine Total R-value Calculations for Volume 1 and Volume 2.

Metal Roof with Raked Ceiling	Heat flow in	Heat flow out
<i>Kingspan AIR-CELL Insulbreak</i> ® 70	R _T 1.9	R _T 1.2

The R-values shown are Total R-values for the building element as required by the Energy Provisions of the NCC Volume 1, calculated in accordance with AS/NZS 4859.2 2018 & NZS 4214. *Kingspan AIR-CELL*® products are manufactured, tested and packaged in conformance with 4859.1:2018.

Specification Guide

The roof insulation fixed to the battens shall be CodeMark-certified *Kingspan AIR-CELL Insulbreak*® (specify 70 or 90) fibre-free, thermo reflective insulation, comprising a cross-linked, closed-cell core sandwiched with an anti-glare foil facing on one side and a plain foil facing on the other side manufactured by Kingspan Insulation Pty Ltd, and shall be installed in accordance with the instructions issued by them.

A Project Specific Warranty provided by Kingspan Insulation must be submitted.

Installation Instructions

1. Lay *Kingspan AIR-CELL Insulbreak*® from the ridge to gutter, over and perpendicular to the roof battens.
2. Ensure a max. 25mm overlap into the gutter and a nominal 40 mm sag between battens is achieved.
3. Allow 150 mm overlap at joins (50 mm is adequate when joins are to be taped - please refer to brochure “Kingspan Insulation Tape” for further information).
4. End joins should be overlapped by 600 mm if not taped.
5. Staple or tape to battens to hold in place until roofing is fixed.

Under Batten Installation

1. Starting at the gutter, roll out the *Kingspan AIR-CELL Insulbreak*® across the rafters with the anti-glare side up, and ensuring a max. 25mm overlap into the gutter is achieved.
2. Fix to rafters.
3. Allow 150 mm minimum overlap for joins (or 50 mm is adequate if joins are to be taped - please refer to brochure “Kingspan Insulation Tape” for further information).
4. End joins should be overlapped by rafter spacing if not taped.
5. Fix battens as per roof cover requirements and applicable

Commercial Metal Deck Roof

Typical Design Details

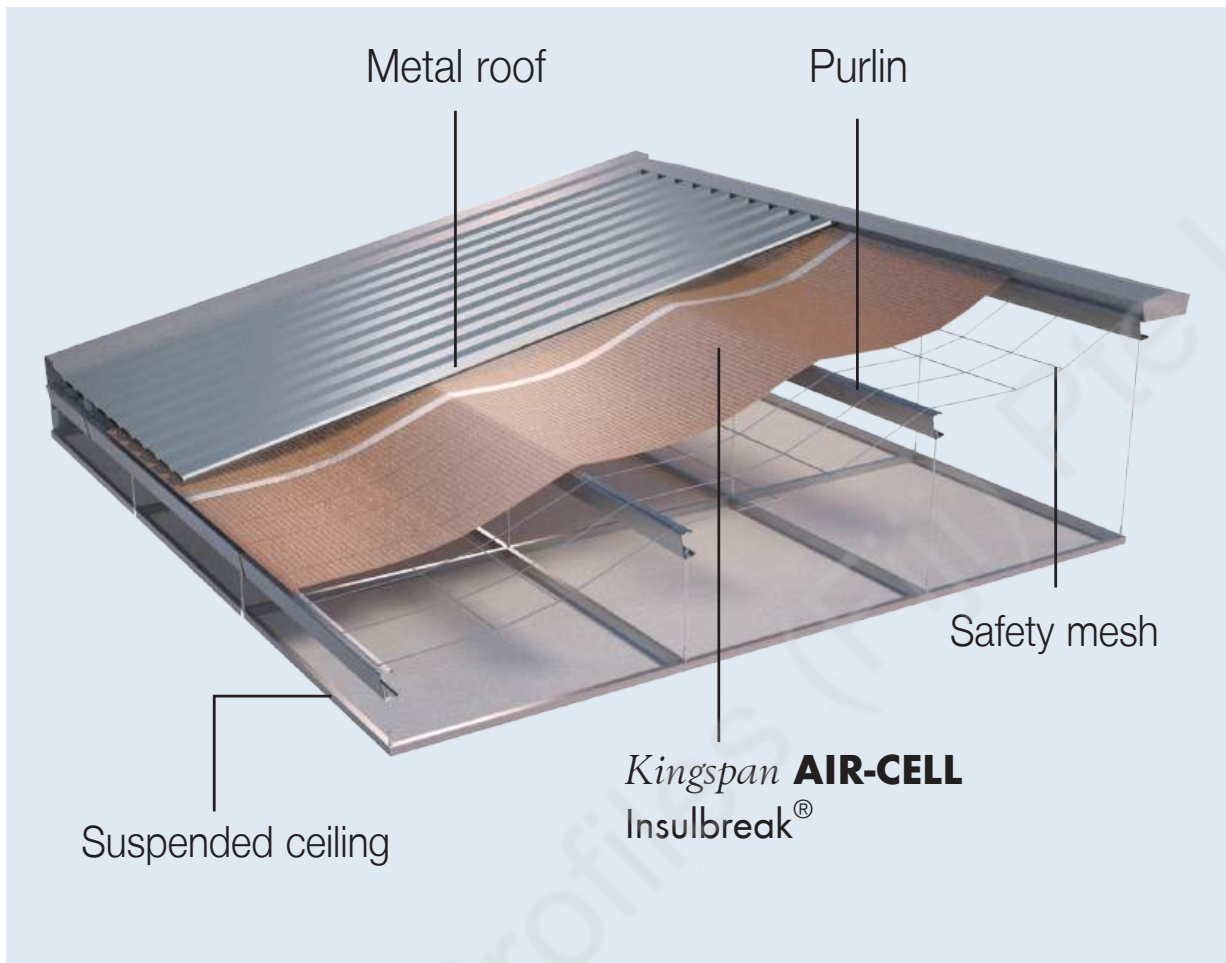

Figure 3 Kingspan **AIR-CELL** Insulbreak® in a commercial office with suspended ceiling installation

Thermal Performance

NCC 2019 prescribes different methods to determine Total R-value Calculations for Volume 1 and Volume 2.

Commercial Office	Heat flow in	Heat flow out
Kingspan AIR-CELL Insulbreak® 55	R _T 2.3	R _T 1.3

The R-values shown are Total R-values for the building element as required by the Energy Provisions of the NCC Volume 1, calculated in accordance with AS/NZS 4859.2 2018 & NZS 4214. Kingspan **AIR-CELL**® products are manufactured, tested and packaged in conformance with AS/NZS 4859.1:2018.

Specification Guide

The roof insulation installed over the purlins shall be CodeMark-certified Kingspan **AIR-CELL** Insulbreak® 55 fibre-free, thermo reflective insulation, comprising a cross-linked, closed-cell foam core sandwiched with an anti-glare foil facing on one side and a plain foil facing on the other side manufactured by Kingspan Insulation Pty Ltd and shall be installed in accordance with the instructions issued by them.

A Project Specific Warranty provided by Kingspan Insulation must be submitted.

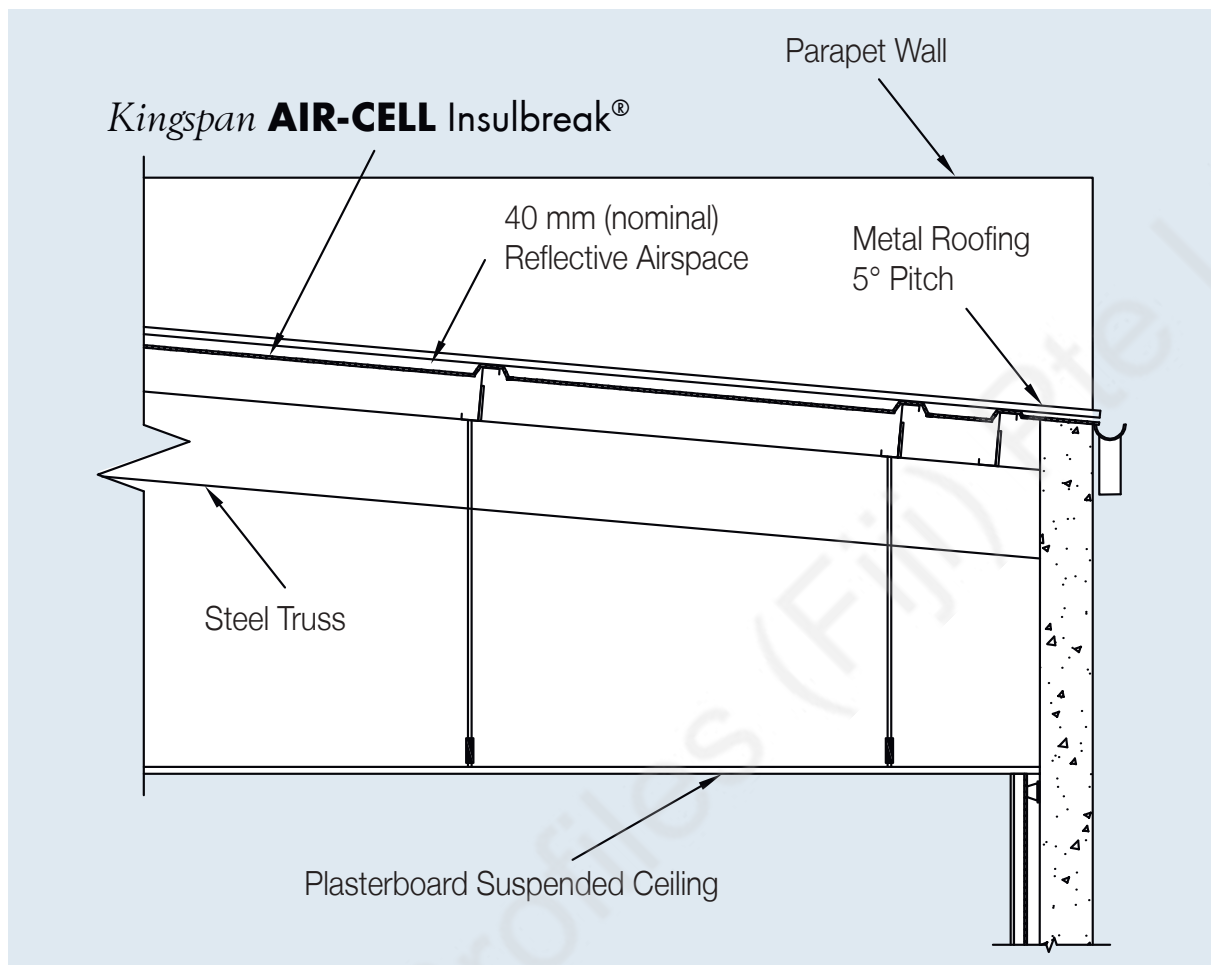

Figure 4 Side elevation of *Kingspan AIR-CELL Insulbreak®* in a commercial office

Installation Instructions

1. Lay *Kingspan AIR-CELL Insulbreak®* perpendicular to purlins ensuring a max. 25mm overlap into the gutter.
2. Allow a nominal 40 mm sag between purlins. If safety mesh is used ensure that the safety mesh is not compromised by sagging.
3. Overlap by 50 mm at joints and apply 72 to 100 mm reinforced foil tape to top of joint (please refer to brochure "Kingspan Insulation Tape" for further information). Alternatively allow 150 mm overlap when joints are not to be taped.
4. End joints should be overlapped by 600 mm if not taped.
5. Fix roof sheeting by screwing through *Kingspan AIR-CELL Insulbreak®* to the purlins.

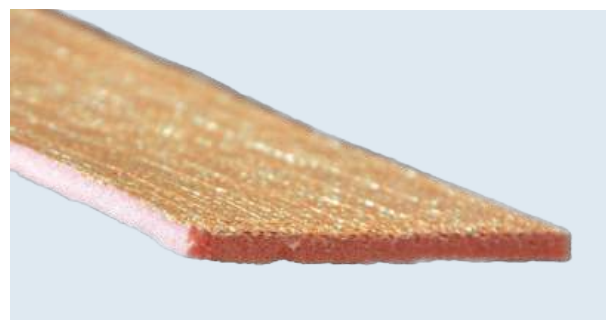

Figure 5 Cross-linked *Kingspan AIR-CELL Insulbreak®*

Commercial Steel-framed Wall

Typical Design Detail

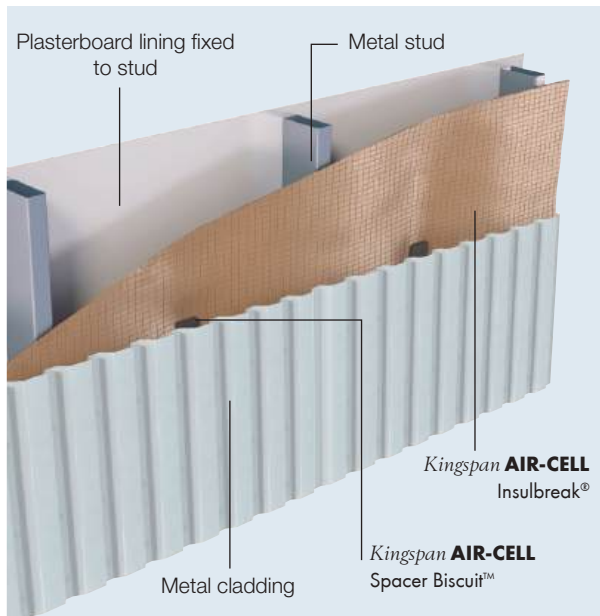

Figure 6 Kingspan AIR-CELL Insulbreak® on steel-framed wall

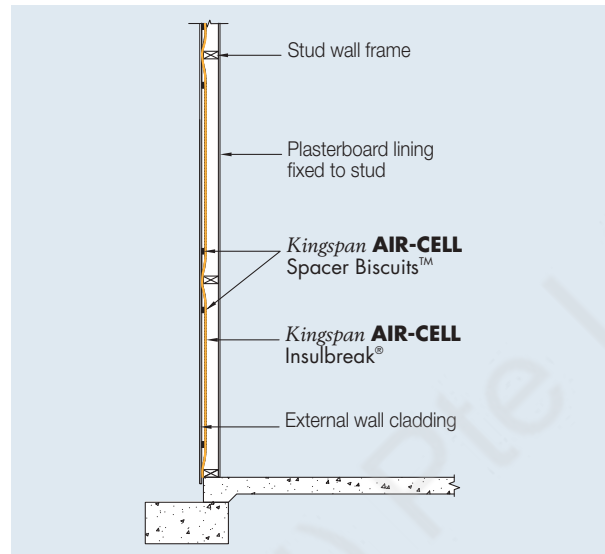

Figure 7 Side elevation of Kingspan AIR-CELL Insulbreak® on steel-framed wall

Thermal Performance

NCC 2019 prescribes different methods to determine Total R-value Calculations for Volume 1 and Volume 2.

Steel-framed Wall	Heat flow in	Heat flow out
Kingspan AIR-CELL Insulbreak® 70	R _T 1.3	R _T 1.3
Kingspan AIR-CELL Insulbreak® 90	R _T 1.4	R _T 1.4

The R-values shown are Total R-values for the building element as required by the Energy Provisions of the NCC Volume 1, calculated in accordance with AS/NZS 4859.2 2018 & NZS 4214. Kingspan AIR-CELL® products are manufactured, tested and packaged in conformance with AS/NZS 4859.1:2018.

Specification Guide

The wall insulation fixed to the outside of the stud frame shall be CodeMark-certified Kingspan AIR-CELL Insulbreak® ____ (specify 70 or 90) fibre-free, thermo reflective insulation, comprising a cross-linked, closed-cell foam core sandwiched with an anti-glare foil facing on one side and a plain foil facing on the other side manufactured by Kingspan Insulation Pty Ltd and shall be installed in accordance with the instructions issued by them.

A Project Specific Warranty provided by Kingspan Insulation must be submitted.

Installation Instructions

1. Fix Kingspan AIR-CELL Insulbreak® loosely to the outside of frame leaving flexibility for the insulation to be dished onto the wall cavity.
2. Cut Kingspan AIR-CELL Insulbreak® carefully around doors, windows and other openings, so that it neatly abuts to frames.
3. Butt join Kingspan AIR-CELL Insulbreak® sheets and tape with a 48 mm wide reinforced foil tape (please refer to brochure "Kingspan Insulation Tape" for further information).
4. Provide for outer air space by adhering the Kingspan AIR-CELL Spacer Biscuits™ to the outer face of the Kingspan AIR-CELL Insulbreak® (approximately three Biscuits™ per square metre required).
5. Commence installing cladding in accordance with manufacturer's installation instructions.

Residential Metal Roof

Typical Design Details

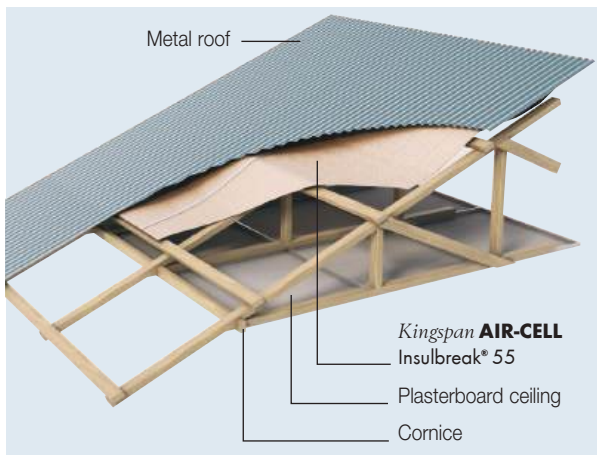

Figure 8 *Kingspan AIR-CELL Insulbreak® 55* in a metal roof with an attic space and flat ceiling

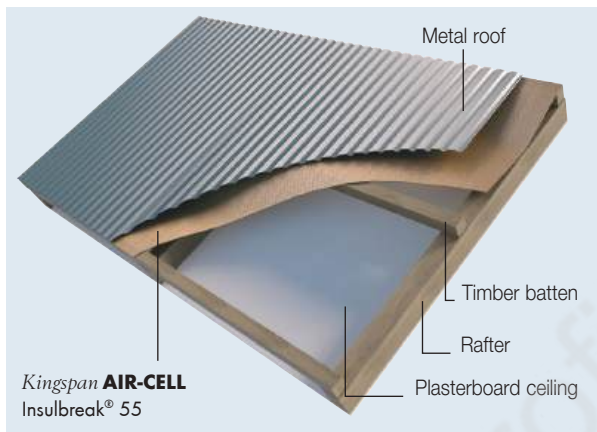

Figure 10 *Kingspan AIR-CELL Insulbreak® 55* in a metal roof with a raked ceiling

Thermal Performance

NCC 2019 prescribes different methods to determine Total R-value Calculations for Volume 1 and Volume 2.

Roof construction	Heat flow in	Heat flow out
Flat ceiling, ventilated	R _T 2.8	R _T 1.1
Flat ceiling, non-ventilated	R _T 2.5	R _T 1.4
Raked ceiling	R _T 2.6	R _T 1.3

The R-values shown are Total R-values for the building element as required by the Energy Provisions of the NCC 2019 Vol 2, calculated in accordance with AS/NZS 4859.2 2018. *Kingspan AIR-CELL®* products are manufactured, tested and packaged in conformance with AS/NZS 4859.1:2018.

Specification Guide

The roof insulation fixed to the battens shall be CodeMark-certified *Kingspan AIR-CELL Insulbreak® 55* fibre-free, thermo reflective insulation, comprising a cross-linked, closed-cell core sandwiched with an anti-glare foil facing on one side and a plain foil facing on the other side manufactured by Kingspan Insulation Pty Ltd, and shall be installed in accordance with the instructions issued by them.

A Project Specific Warranty provided by Kingspan Insulation must be submitted.

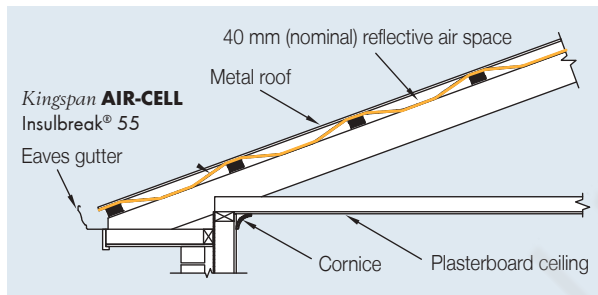

Figure 9 Side elevation of *Kingspan AIR-CELL Insulbreak® 55* in a metal roof with an attic space and flat ceiling

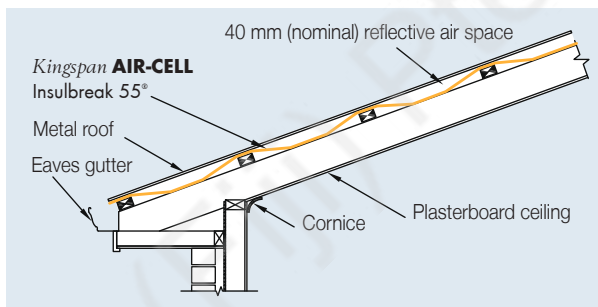

Figure 11 Side elevation of *Kingspan AIR-CELL Insulbreak® 55* in a metal roof with a raked ceiling

Installation Instructions

1. Lay *Kingspan AIR-CELL Insulbreak® 55* from the ridge to gutter, over and perpendicular to the roof battens.
2. Ensure a max. 25mm overlap into the gutter and a nominal 40 mm sag between battens is achieved.
3. Allow 150 mm overlap at joints (50 mm is adequate when joints are to be taped - please refer to brochure 'Kingspan Insulation Tape' for further information).
4. End joints should be overlapped by 600 mm if not taped.
5. Staple or tape to battens to hold in place until roofing is fixed.

Under Batten Installation

Apply as per Residential Tiled Roof installation instructions.

Residential Tiled Roof

Typical Design Details

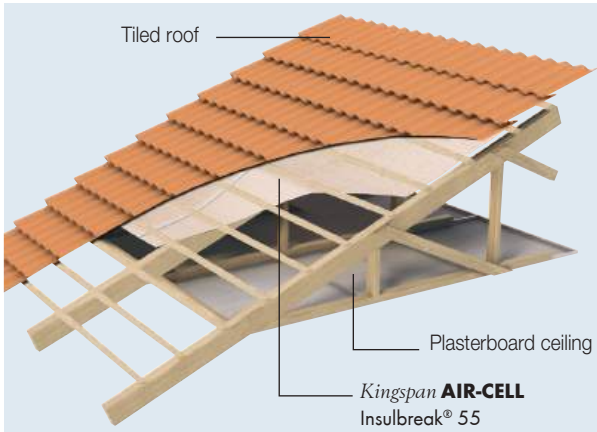

Figure 12 **Kingspan AIR-CELL Insulbreak® 55** in a tiled roof with an attic space and a flat ceiling

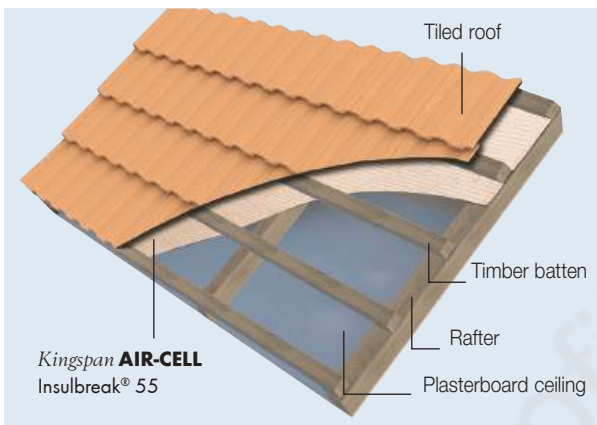

Figure 14 **Kingspan AIR-CELL Insulbreak® 55** in a tiled roof with a raked ceiling

Thermal Performance

NCC 2019 prescribes different methods to determine Total R-value Calculations for Volume 1 and Volume 2.

Roof construction	Heat flow in	Heat flow out
Flat ceiling, ventilated	$R_T 2.2$	$R_T 1.0$
Flat ceiling, non-ventilated	$R_T 2.0$	$R_T 1.2$
Raked ceiling	$R_T 2.0$	$R_T 1.1$

The R-values shown are Total R-values for the building element as required by the Energy Provisions of the NCC 2019 Vol. 2, calculated in accordance with AS/NZS 4859.2 2018. Kingspan AIR-CELL® products are manufactured, tested and packaged in conformance with AS/NZS 4859.1:2018.

Specification Guide

The roof insulation fixed to the top of the rafters shall be CodeMark-certified **Kingspan AIR-CELL Insulbreak® 55** fibre-free, thermo reflective insulation, comprising a cross-linked, closed-cell core sandwiched with an anti-glare foil facing on one side and a plain foil facing on the other side manufactured by Kingspan Insulation Pty Ltd, and shall be installed in accordance with the instructions issued by them.

A Project Specific Warranty provided by Kingspan Insulation must be submitted.

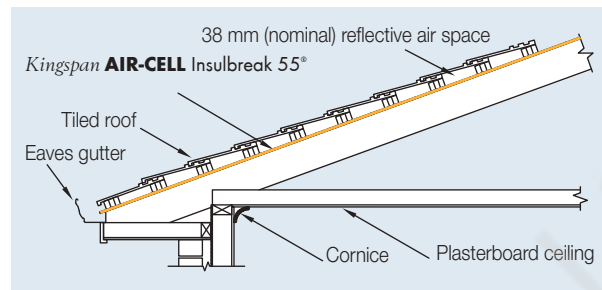

Figure 13 Side elevation of **Kingspan AIR-CELL Insulbreak® 55** in a tiled roof with an attic space and a flat ceiling

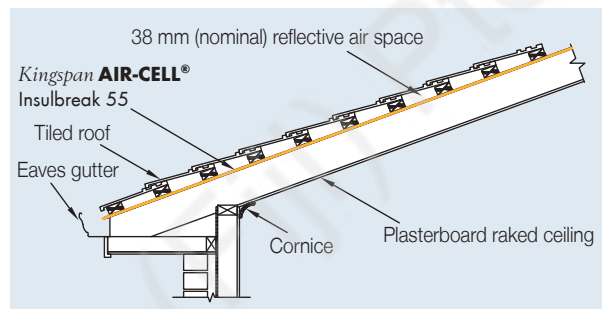

Figure 15 Side elevation of **Kingspan AIR-CELL Insulbreak® 55** in a tiled roof with a raked ceiling

Installation Instructions

1. Starting at the gutter, roll out the **Kingspan AIR-CELL Insulbreak® 55** across the rafters with the anti-glare side up, and ensuring a max. 25mm overlap into the gutter is achieved.
2. Fix to rafters.
3. Allow 150 mm minimum overlap for joints (or 50 mm is adequate if joints are to be taped - please refer to brochure 'Kingspan Insulation Tape' for further information).
4. End joints should be overlapped by rafter spacing if not taped.
5. Fix battens as per roof cover requirements and applicable standards.

Residential Steel-framed Wall

Typical Design Detail

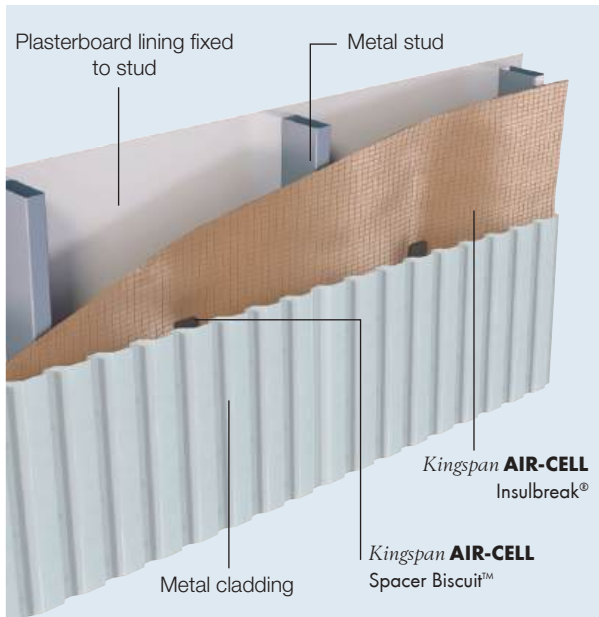

Figure 16 Kingspan AIR-CELL Insulbreak® on steel-framed wall

Thermal Performance

NCC 2019 prescribes different methods to determine Total R-value Calculations for Volume 1 and Volume 2.

Steel-framed Wall	Heat flow in	Heat flow out
Kingspan AIR-CELL Insulbreak® 70	R _T 1.8	R _T 1.8
Kingspan AIR-CELL Insulbreak® 90	R _T 1.8	R _T 1.8

The R-values shown are Total R-values for the building element as required by the Energy Provisions of the NCC 2019 Vol. 2, calculated in accordance with AS/NZS 4859.2 2018. Kingspan AIR-CELL® products are manufactured, tested and packaged in conformance with AS/NZS 4859.1:2018.

Specification Guide

The wall insulation fixed to the outside of the stud frame shall be CodeMark-certified Kingspan AIR-CELL Insulbreak® ____ (specify 70 or 90) fibre-free, thermo reflective insulation, comprising a cross-linked, closed-cell foam core sandwiched with an anti-glare foil facing on one side and a plain foil facing on the other side manufactured by Kingspan Insulation Pty Ltd and shall be installed in accordance with the instructions issued by them.

A Project Specific Warranty provided by Kingspan Insulation must be submitted.

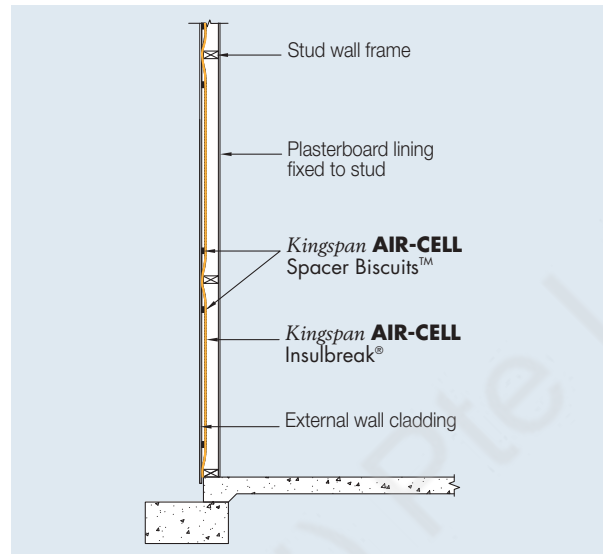

Figure 17 Side elevation of Kingspan AIR-CELL Insulbreak® on steel-framed wall

Installation Instructions

1. Fix Kingspan AIR-CELL Insulbreak® loosely to the outside of frame leaving flexibility for the insulation to be dished onto the wall cavity.
2. Cut Kingspan AIR-CELL Insulbreak® carefully around doors, windows and other openings, so that it neatly abuts to frames.
3. Butt join Kingspan AIR-CELL Insulbreak® sheets and tape with a 48 mm wide reinforced foil tape (please refer to brochure "Kingspan Insulation Tape" for further information).
4. Provide for outer air space by adhering the Kingspan AIR-CELL Spacer Biscuits™ to the outer face of the Kingspan AIR-CELL Insulbreak® (approximately three Biscuits™ per square metre required).
5. Commence installing cladding in accordance with manufacturer's installation instructions.

Product Details

Product Description

Australian-made **Kingspan AIR-CELL Insulbreak®** is a 3-in-1 insulation, vapour barrier and thermal break solution for steel-framed construction. In steel-framed buildings **Kingspan AIR-CELL Insulbreak® 70** and **Insulbreak® 90** delivers the R0.20 thermal break required for NCC BCA compliance*, reducing thermal bridging and conductivity between building elements. **Kingspan AIR-CELL Insulbreak®** is also commonly used in non-steel framed applications such as timber framed roofs.

The **Kingspan AIR-CELL Insulbreak®** is suitable to provide a thermal break for metal framed walls on low rise structures. For consideration in high-rise buildings, please contact Kingspan Insulation's Technical Services Team.

CodeMark-certified **Kingspan AIR-CELL Insulbreak®** is manufactured with a patented physically cross-linked, closed-cell foam structure, and sandwiched by highly reflective foil surfaces.

* Refer to NCC BCA Vol. 1 Section J 0.4, 0.5; Vol. 2 3.12.1.2, 3.12.1.4

Management Standards

Standard	Management System
ISO 9001:2015	Quality Management
ISO 14001:2015	Environmental Management

Product Data	AIR-CELL Insulbreak® 70	AIR-CELL Insulbreak® 90	AIR-CELL Insulbreak® 55
Product Thickness (nom.)	7.2 mm	9.0 mm	5.5 mm
Product R-value at 23°C	R0.20 m ² .K/W	R0.25 m ² .K/W	R0.15 m ² .K/W
Roll Diameter (nom.)	450 mm	500 mm	410 mm
Roll Weight (nom.)	9.15 kg	10 kg	7.7 kg
Roll Size	1350 mm x 22.25 m (30 m ²)		
Reflectance			
Anti-Glare Face	95%		
Reflective Face	97%		
Emittance			
Anti-Glare Face	E0.05		
Reflective Face	E0.03		
Max. Span	2.4 m without support mesh		

Product Specifications

Property	Test Method / Standard	Specification	Classification
Flammability Index	AS 1530.2	≤ 5	Low
Material R-value	ASTM C518 at 23°C	0.20 m ² .K/W (7.2mm thickness) 0.25 m ² .K/W (9.0mm thickness)	-
IR Emittance	AS/NZS 4201.5	Reflective Face: 0.03 Anti-Glare Face:0.05	IR Reflective IR Reflective
IR Emittance	-	-	Category RR
Burst Strength	AS 3706.4 (CBR)	1.0 kN	-
Vapour Control	ASTM E96	Vapour Barrier	Class 2
Water Control	AS/NZS 4201.4	Pass	Water Barrier
Moisture Shrinkage	AS/NZS 4201.3	< 0.5%	-
Dry Delamination	AS/NZS 4201.1	Pass	-
Wet Delamination	AS/NZS 4201.2	Pass	-
Surface Water Absorbency	AS/NZS 4201.6	< 100g/m ²	Low
Corrosion Resistance	AS/NZS 4859.1:2018 App. E	Pass	-
Electrical Conductivity	AS/NZS 200.1:2017 - c.5.3.1.2	Resistance ≤ 10MΩ	Electrically Conductive

General Requirements

1. Fit *Kingspan AIR-CELL*® neatly around doors, windows, and any penetrations, and tape if necessary to prevent air leakage.
2. When taping a plastic squeegee or blade must be used to apply appropriate pressure to the tape. Surfaces must be dry and free from dust, oil or grease prior to taping (please refer to brochure 'Kingspan Insulation Tape' for further information).
3. Leave minimum 100 mm clearance around heat producing flues or light fittings (refer to light fitting manufacturer).

The instructions in this document are guidelines only and should be interpreted with consideration for the specific building design. The installation of *Kingspan AIR-CELL*® should be in conformance with the applicable clauses from AS 3999 and AS/NZS 4200.2 unless otherwise specified.

Should there be specific Local Government standards and/or specific climate requirements, install instructions can be changed accordingly. Alternative install instructions can be provided on request.

Kingspan AIR-CELL® can be damaged by intense heat above 105° C and contact with sparks and flame from blow torches, welders, cutting tools, etc. must be avoided.

The installer must make due provision for safety when installing *Kingspan AIR-CELL*® in any application.

Safety Information

- Non-hazardous/non-toxic.
- No personal protective equipment required.
- UV protective sunglasses and screen should be used when installing in direct sunlight.
- Ensure at least 100 mm clearance from hot flues and light fittings (check for safe distance with lighting supplier).
- **Foil facings are conductive to electricity - avoid contact with un-insulated electrical cables and fittings.**

Handling and Storage

Kingspan AIR-CELL® insulation products must be transported and stored in its protective packaging and kept clean and dry. Standing rolls on end reduces risk of damage should moisture be present in the packaging. Surfaces must be kept free of contaminants such as dust and grease, and must not be stored with foil surfaces in contact with alkaline materials i.e. wet cement, lime, etc.

Environmental Data

Aspect	Characteristic
Recyclability	Waste not recyclable Roll width to suit most applications to minimise on site waste
Re-usability	Re-usable if removed with care (long term of service expected)
Water Use	No water used in manufacturing process
Ozone Depleting Substances	None present in the finished product
Packaging	Packaging 100% recyclable
Embodied Energy	43 MJ/m ² approximately

Contact Details

General Enquiries

Tel: 1300 247 235

Email: info@kingspaninsulation.com.au

Kingspan Insulation Pty. Ltd. reserves the right to amend product specifications without prior notice. The information, technical details and fixing instructions etc. included in this literature are given in good faith and apply to uses described. Recommendations for use should be verified as to the suitability and compliance with actual requirements, specifications and any applicable laws and regulations. For other applications or conditions of use, Kingspan Insulation offers a Technical Advisory Service the advice of which should be sought for uses of Kingspan Insulation products that are not specifically described herein. Please check that your copy of the literature is current by contacting us or visiting www.kingspaninsulation.com.au



Kingspan Insulation Pty Ltd

Tel: 1300 247 235

Email: info@kingspaninsulation.com.au

www.kingspaninsulation.com.au