



ROOFING & PROFILES (FIJI) PTE LTD

Build With Confidence

RPFL STEEL PURLIN



P.O Box 9, Yalelevu, Kings Rd, Ba, Fiji Islands | Phone: (679) 667 3764 | Mob: (679) 9999341

✉ info@roofingandprofiles.com.fj | 🌐 www.roofingandprofiles.com.fj



The Complete Purlin And Girt System

The Roofing & Profiles (Fiji) Ltd (RPFL) Cee and Zed Purlin sections range from 100 to 300 mm and are accurately roll-formed from in a Hayes NZ machine from high strength Zinc coated steel - G450 Z450 and combine to provide efficient, lightweight, economical roofing and cladding support system for framed structures. The system, which includes a comprehensive range of accessories, is supplied ready for erection and, once erected, requires minimal maintenance throughout the life of the building.

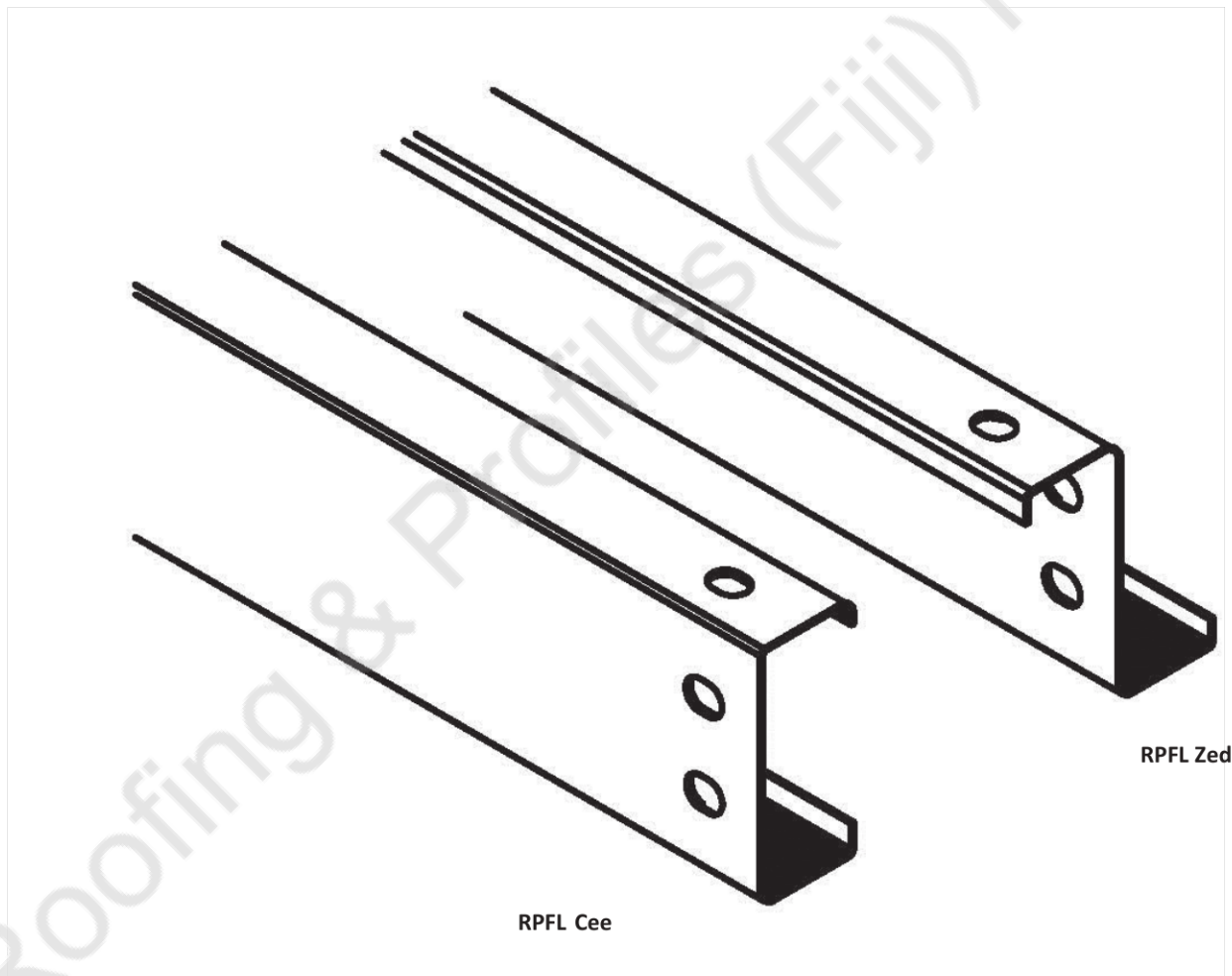

General data for Cee and Zed Sections

Applications

RPFL Cee sections may be used in single spans and unlapped continuous spans in multi-bay buildings. Cee sections are ideal as eave purlins or where compact sections are required for detailing. Cee sections cannot be lapped.

RPFL Zed sections may be used over single spans, unlapped continuous and lapped continuous spans in multi-bay buildings. Lapped continuous spans result in a considerable capacity increase in the system

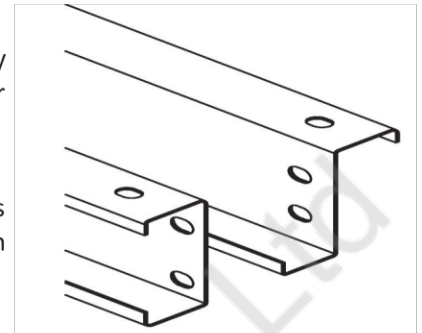

RPFL Cee

RPFL Zed

Range of products & services

Our wide range includes

- A full range of RPFL Cees and Zeds;
- A full range of RPFL Cees and Zeds with downturned-lip;
- Section sizes from 100 mm to 300 mm;
- Technical information for cleat less connections (see Design notes for capacity tables);
- Bridging systems;
- Bolting systems to suit project needs;
- Advice on improving the life expectancy of purlin systems in corrosive environments;

Performance

In accordance with the provisions of AS/ANZ 4600:1996 **Cold-formed** steel structures, load capacities have been calculated for RPFL sections using approved RPFL bridging systems, bolting and other accessories. Sections chosen using the data provided in the tables will perform as specified when the design, fabrication and erection are carried out in accordance with RPFL recommendations and accepted building practice.

Standard range of RPFL Cees and Zeds

Nominal section size (mm)	BMT		
100		1.9	
150	1.5	1.9	2.4
200	1.5	1.9	2.4
250		1.9	2.4
300		2.4	3.0

Non-standard sections

We can supply a wide range of non-standard sizes (up to 300 mm) and shapes, including Cees and Zeds with downturned lip—the Zeds can also be made to lap.

Corrosion protection & material compatibility

Some building materials and environmental conditions can be detrimental to coated steel products. These include contact with or exposure to runoff from:

- Industrial, agricultural, marine or other aggressive atmospheric conditions;
- Incompatible metals, like lead or copper;
- Building materials subject to cycles of dryness and wetness, or which have excessive moisture content such as improperly seasoned timber.
- Materials which have been treated with preservatives, like CCA or tanalith-treated timber.

A zinc coating of Z450 (450 g/m² minimum coating mass) is the standard coating class provided with RPFL Cee and Zed sections. This will provide a long and trouble-free life for enclosed buildings and open-sided rural buildings, in a non-aggressive environment and also meets the Fiji Standards.

A non-aggressive environment is 1000 m from rough surf, 750 m from industrial emission and fossil fuel combustion, and 300 m from calm salt waters. Consideration must be given to the nature of activities performed within the building. For severe corrosive environments Z450 (450 g/m² minimum coating mass) is required. All our Purlin raw materials are imported and supplied in Z450 coating.

Direct contact of incompatible materials with the coating must be avoided. In such applications, and in very corrosive environments, suitable paint systems can be obtained from paint manufacturers.

In applications where, particular attention is required for corrosion, or the buildup of substances like dust or grain, then consideration should be given to the shape of the sections (either Zed, or Cee, or Zed with downturned lip); orientation of the sections; and coating class.

Available lengths

RPFL purlins are available custom-cut in any transportable length, however there are some limitations.

Minimum length 1.2m and maximum length unlimited, (refer note below transportation)

For normal deliveries nominal lengths should not exceed 10.900 m. Lengths greater than 10.900 m require special transportation and on-site handling. We can roll form up to 25 meter lengths or longer if required.

Length tolerance for all sections is ±5 mm.

RPFL Cee and Zed sections are delivered in strapped bundles. The actual quantity in each bundle will vary with section size, order and length.

Storage on-site

If not required for immediate use, sections should be neatly stacked off the ground and on a slight slope so that water can drain away. Sections and accessories should not be left exposed in the open for extended periods.

Material specifications

RPFL Cee and Zed sections are roll-formed from GALVASTEEL - steel complying with AS1397—2001. In the grades shown, the number prefixed with G indicates minimum yield stress in Mpa; and the number prefixed with Z indicates minimum coating mass in g/m².

- 1.5, 1.9, 2.4 and 3.0mm BMT: G450, Z450

Bolt specification with Nut and Washer

Nominal section size (mm)	Bolt Specification
100, 150, 200, 250,	M12 RPFL purlin bolt: standard (grade 4.6) or high strength (grade 8.8)
300	M16 RPFL purlin bolt: standard (grade 4.6) or high strength (grade 8.8)

Cees and Zeds Sections

Dimensions and properties

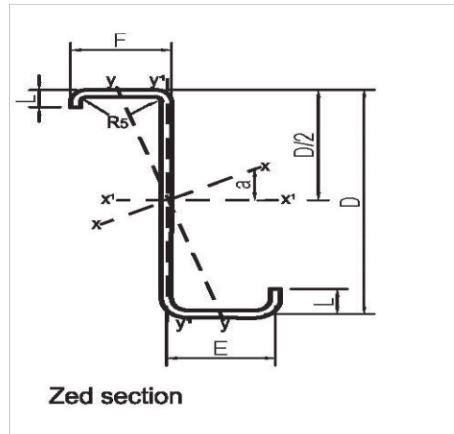
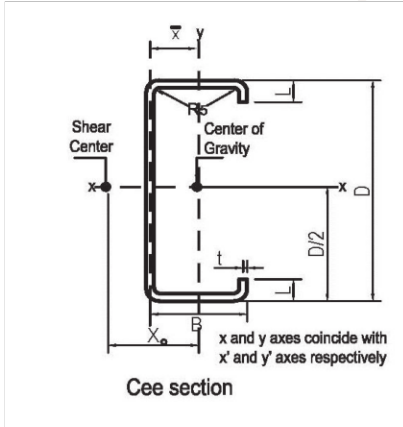

RPFL Cee sections

RPFL Cee sections have equal flanges and are suitable for simply supported spans. For shorter spans they may be used continuously over two or more spans with the ends butted, thus producing reduced deflection compared with simple spans. They cannot be lapped.

Typical assemblies are shown later in this manual.

RPFL Zed sections

RPFL Zed sections feature one broad and one narrow flange, sized so that two sections of the same size fit together snugly, making them suitable for lapping.

Continuous lengths of purlin result in better economy, but lapping provides two thicknesses of metal over interior supports. Lapping increases the strength of the sections where bending moments and shear are at a maximum, thus improving the load capacity and rigidity of the system.

RPFL Zed sections of the same depth and different thicknesses can be lapped in any combination.

RPFL Zed sections may also be used over simple spans. For shorter spans they may be used continuously over two or more spans without laps—thus producing reduced deflection compared with simple spans—but it does not give the strength of a fully lapped system.

RPFL Zed sections with one lip turned outward (called downturned lip purlins) may be used in simple or continuous spans with the ends butted.

Typical assemblies are shown later in this manual.

Dimensions of Cees and Zeds

Catalogue number	t mm	D mm	Mass per unit length kg/m	ZEDS				Cees
				E mm	F mm	L mm	B mm	L mm
Z/C10019	1.9	102	3.29	53	49	14.5	51	14.5
Z/C15015	1.5	152	3.59	65	61	16.5	64	15.5
Z/C15019	1.9	152	4.51	65	61	17.5	64	16.5
Z/C15024	2.4	152	5.70	66	60	19.5	64	18.5
Z/C20015	1.5	203	4.49	79	74	15.0	76	15.5
Z/C20019	1.9	203	5.74	79	74	18.5	76	19.0
Z/C20024	2.4	203	7.24	79	73	21.5	76	21.0
Z/C25019	1.9	254	6.50	79	74	18.0	76	18.5
Z/C25024	2.4	254	8.16	79	73	21.0	76	20.5
Z/C30024	2.4	300	10.09	100	93	27.0	96	27.5
Z/C30030	3.0	300	12.76	100	93	31.0	96	31.5

Section properties

Section properties of RPFL Cees

Full section properties									Column properties				Effective section properties at yield stress	
Product Cod	Area	Second moment of area		Section modulus		Radius of gyration		Centroid	Shear centre	Torsion constant	Warping constant	Mono-symmetry section constant	Section modulus in bending	Area in compression
		Ix	Iy	Zx	Zy	rx	ry							
	mm ²	10mm ⁴	10 ⁶ mm ⁴	10mm	10mm	mm	mm	mm	mm	mm	10mm	mm	10mm	mm
C10019	409	0.673	0.142	13.2	421	40.6	18.7	162	404	492	311	122	123	329
C15015	443	1.61	0.237	21.1	5.29	60.2	23.1	18.4	469	332	1070	171	17.1	244
C15019	561	2.02	0.300	26.6	6.74	60.0	23.1	18.5	47.1	675	1370	170	21.8	340
C15024	712	254	0.386	33.5	8.79	59.8	23.3	18.9	480	1370	1810	169	309	527
C20015	555	3.53	0.396	34.7	7.17	79.7	26.7	19.9	516	416	3060	223	241	251
C20019	713	4.51	0.531	44.4	9.77	79.6	27.3	20.8	53.6	858	4240	221	36.6	381
C20024	904	5.69	0.681	56.0	127	79.3	27.4	21.1	54.4	1740	5540	219	47.5	541
C25019	808	7.62	0.561	60.0	9.86	97.1	26.4	18.1	48.5	972	6860	276	46.2	381
C25024	1020	9.62	0.721	75.7	128	96.9	26.5	18.4	49.3	1970	8920	274	64.9	543
C30024	1260	17.0	1.57	113	21.7	116	34.6	25.0	66.0	2430	26800	320	91.1	632
C30030	1600	21.3	1.96	142	28.5	116	35.0	25.8	67.9	4790	35700	316	124	897

Properties have been computed on the basis of mean flange width. The introduced error is negligible. The shear centre and monosymmetry constant deviations can be disregarded, that is, taken as zero.

Section properties of RPFL Zeds

Full section propendicular											Columnn properties		Effective section properties at yield stress				
Product Code	Area	Principal axes			Section Radius of modulus Gyration			Axes perpendicular & parallel to web				Torsion constant	Warping constant	Section modulus in bending	Area in compression		
		Second Moment of area			Zy	ry	a	Second moment of area	Product of moment of area	Section modulus	Radius of gyration						
	A	Ix	Iy	Zy	ry	a	Ix	Iy'	Ix' y'	Zy'	Zy'	rx'	ry'	J	Iw	Zx'e	Ae
	mm	10mm	10mm	10mm	mm	()	10mm	10 ⁶ mm ⁴	10 ⁶ mm ⁴	10 ⁶ mm ⁴	10 ⁶ mm ⁴	mm	mm	mm ⁴	10 ⁶ mm ⁴	10 mm	mm ²
Z10019	409	0.84	0.0829	2.94	14.2	28.1	0.673	0.25	314	13.0	4.92	40.6	24.7	492	409	12.4	329
Z15015	443	1.84	0.145	3.96	18.1	22	1.60	0.383	588	20.8	6.06	60.1	29.4	332	1460	17.2	248
Z15019	561	2.32	0.184	5.02	18.1	22.1	2.01	0.487	0.744	26.1	7.73	59.9	29.5	675	1860	22.4	347
Z15024	712	2.92	0.238	6.38	18.3	22.5	2.53	0.632	0.95	326	10	59E	29.8	1370	2410	31.4	535
Z20015	555	3.89	0.255	5.53	21.4	18.5	3.53	0.621	1.09	34.3	8.05	79.7	33.4	416	4260	23.8	248
Z20019	713	5.02	0.342	7.45	21.9	19.1	4.52	0.843	1.45	43.9	11.0	79j6	34.4	858	5830	36.4	378
Z20024	907	6.36	0.443	9.64	22.1	19.4	5.70	1.10	1.86	55.3	14.4	793	34.8	1740	7630	48.4	546
Z25019	808	8.08	0.381	7.82	21.7	14.0	7.62	0.833	1.81	59.3	10.8	97.1	32.1	972	9480	45.7	379
Z25024	1030	10.2	0.493	10.2	21.9	14.3	9.64	1.08	2.33	74.9	14.2	96.9	32.5	1970	12400	66.0	547
Z30024	1260	18.3	1.01	16.8	28.3	16.0	17.0	2.32	4.57	112	23.8	116	42.8	2430	36600	89.9	628
Z30030	1600	23.1	1.32	21.9	28.7	16.3	21.3	3.04	5.88	140	31.4	116	43.6	4790	48200	125	908

RPFL 100, 150, 200, 250 Series Bridging System

Bridging piece

Purlins are normally braced by Alternating bridging member and Tie rods. For flat roofs, up to 10 Slope, alternate bridging without Tie rods may be used (engineer to confirm).

Bridging End Dimensions

Purlin depth (mm)	A (mm)	B (mm)	C
102	65	40	Purlin spacing less 2mm
152	115	60	
203	160	110	
254	215	160	
300	260	210	

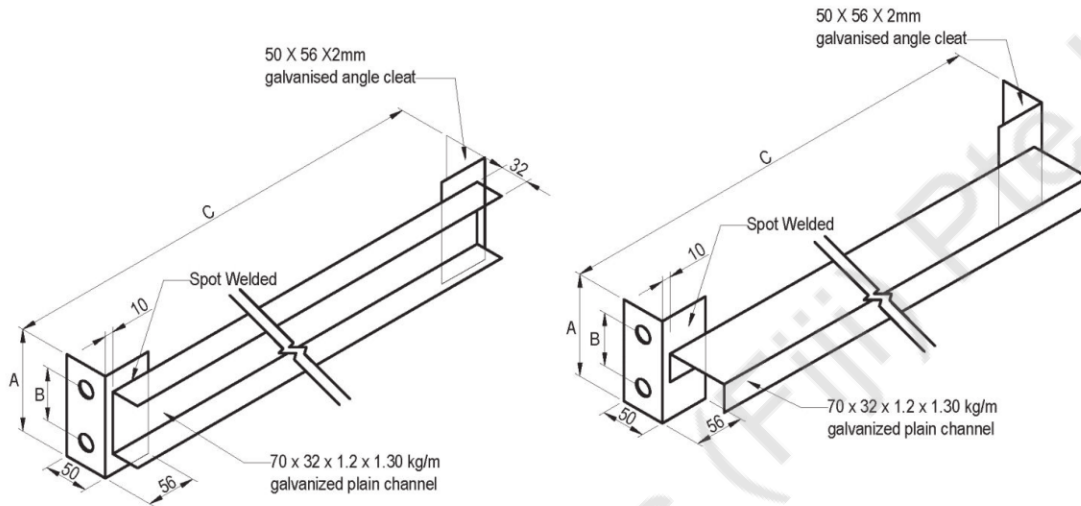

All components are made from pre-galvanized material for long lasting and can be assembled using the recommended bolts or by welding.

When ordering the overall bridging length should be specified, i.e. purlin or girt spacing, less 3mm.

RPFL 300 Series Bridging System

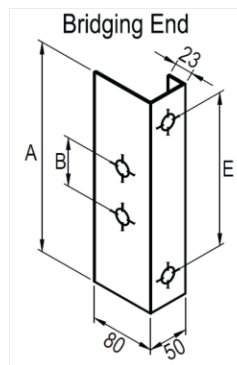
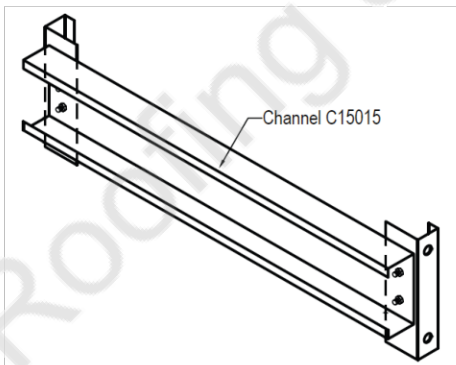

300 Series Bridging end Dimensions

Depth of purlin (m)	Catalogue No.	Dimensions (mm)		
		A	B	E
300	300 EB	260	60	210
300	300 EBV	260	70	210

For the largest sections, 300 series (Zeds and Big Ceas), a more substantial bridging system is required, due to larger spans and greater loads.

These components consist of a C15015 channel and bridging ends assembled with high strength M12 x 30mm purlin

The bridging components are bigger and have additional lip stiffening

Cee Purlin Bridging and tie rod arrangement

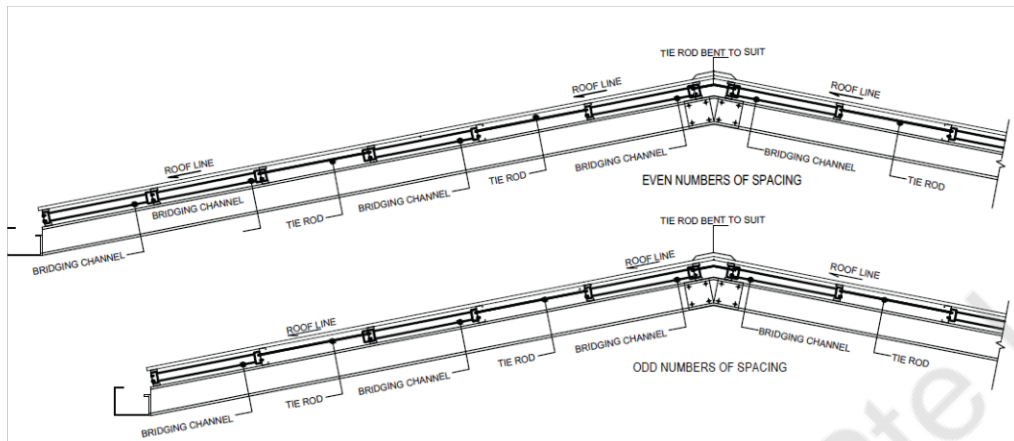

Zed Purlin Bridging and tie rod arrangement

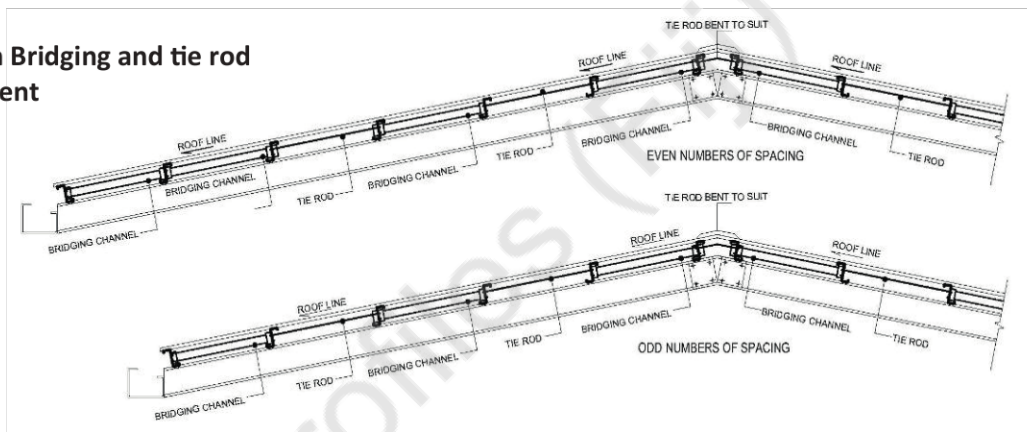

Tie rod (ZP or GALVANISED)
Girts are supported only by tie rods, which also act as braces for outward (wind suction) loads.

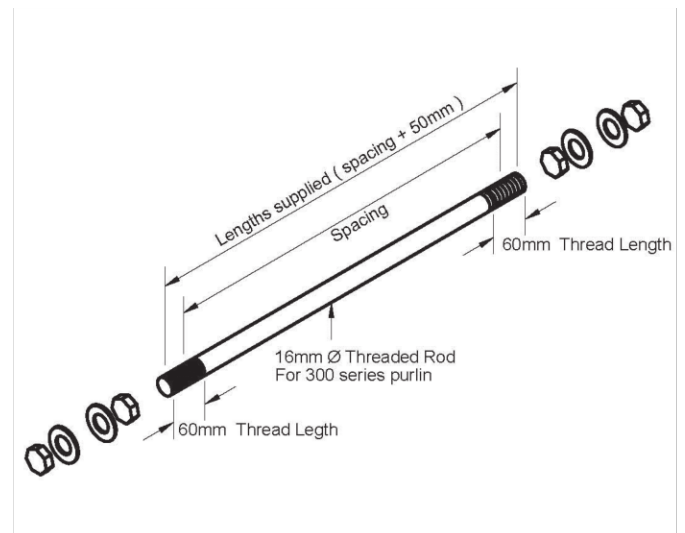
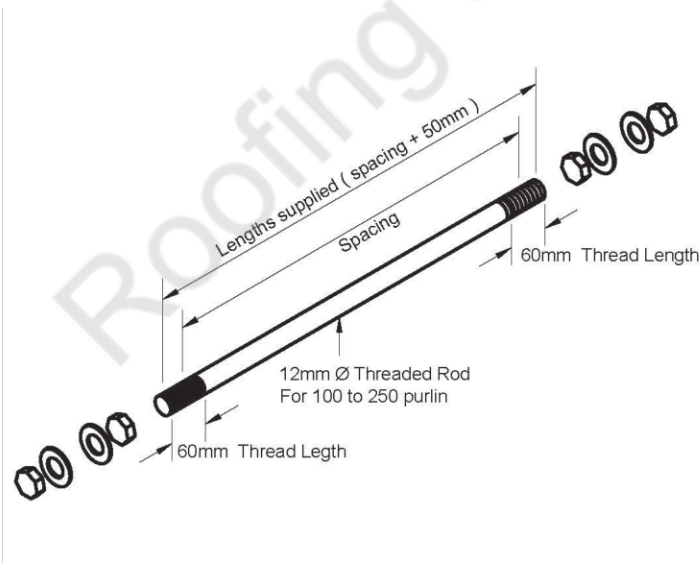

Cee Purlin bridging system

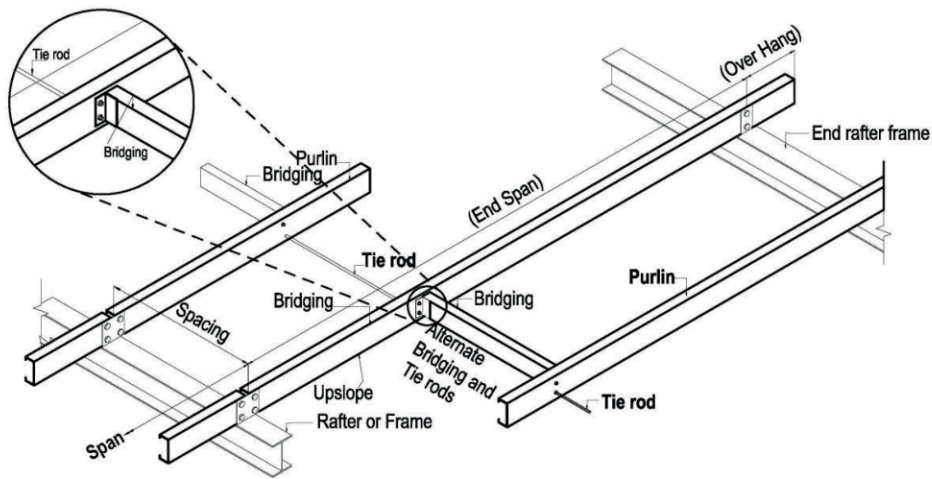

Typical arrangement of in-line C Purlins

Upperlip of C purlin should face up the slope.

Outside

Lip of girts should face upwards.

Zed Purlin bridging system

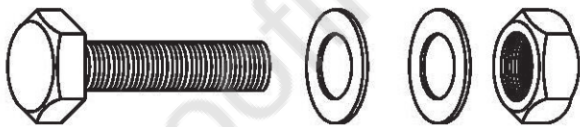
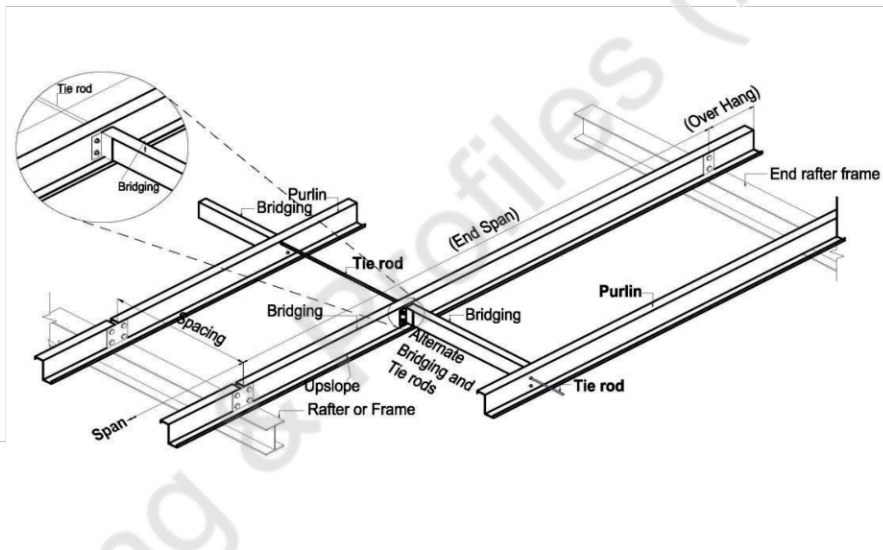

Standard purlin bolt, nut and washer M12 x 30mm grade 4.6 ZP/HD Galv.
High strength purlin bolt
M12 x 30 grade 8.8 with bolt, nut and washer ZP/HD Galv.

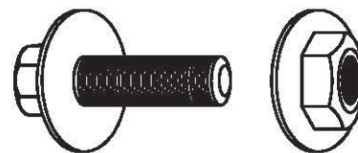

Standard purlin bolt (grade 4.6): M12 x 30mm with nut.
High-strength purlin bolt (grade 8.8): M12 x 30mm with nut.
Shouldered purlin bolt (grade 4.6) with 16mm shoulder: M12 x 30mm with nut.
Standard purlin bolt (grade 4.6): M16 x 45mm with nut.
High-strength purlin bolt (grade 8.8): M16 x 45mm with nut for 300 series purlins.

Holes & Cleats

RPFL Cee and Zeds sections are normally supplied with 18 x 22mm elongated holes punched to the Australian Institute of Steel Construction gauge lines. They are intended for use with standard M12 purlin bolts. Where reactions are greater than the allowable load on two standard M12 purlin bolts or greater strength bolts are desired, High strength M12 or M16 purlin bolts are recommended. Sections are also available unpunched if required. M16 purlin bolts are recommended for 300 series purlins.

Nominal section size (mm) G(mm) D_H

Nominal section size (mm)	G(mm)	D _H
100	40	18
150	60	18
200	110	18
250	160	18
300	210	18

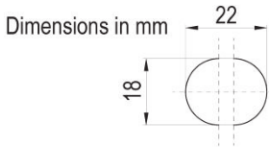

RPFL Building Products standard elongated punched hole. Holes equally spaced above and below centre line.

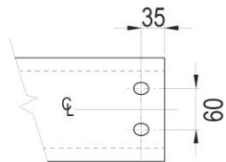

150 Series Cee and Zed

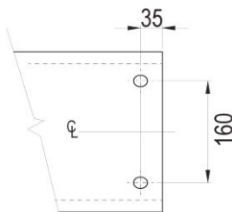

250 Series Cee and Zed

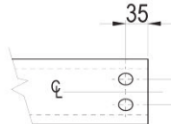

100 Series Cee and Zed

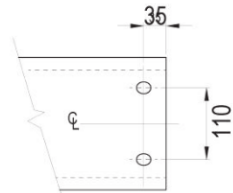

200 Series Cee and Zed

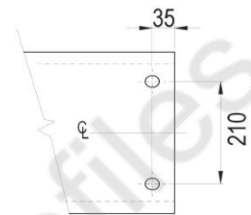

300 Series Cee and Zed

Centreline holes for 300 sections only



Bridging holes and cleat holes

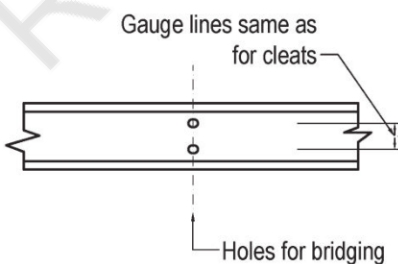

The holes are required at cleat supports at end of lap and at bridging point. For the web of 100, 150, 200 and 250 deep sections the holes are elongated with dimensions of 18mm suitable for M12 bolts. For 300mm sections 18mm suitable for M16 bolts.

Standard holes for Cee sections

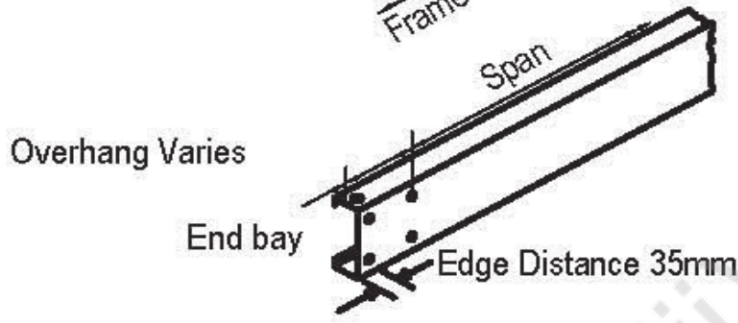
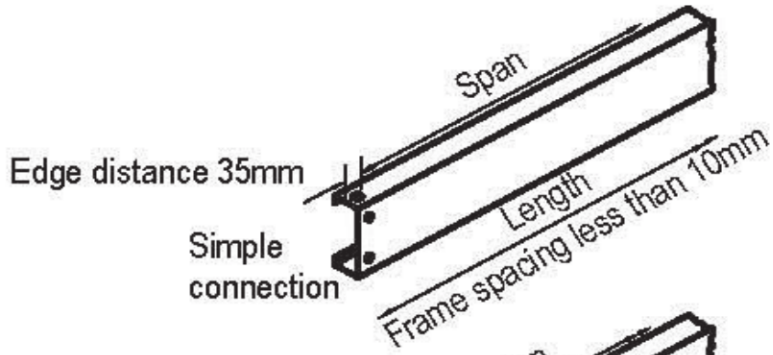

End holes - Zed Section

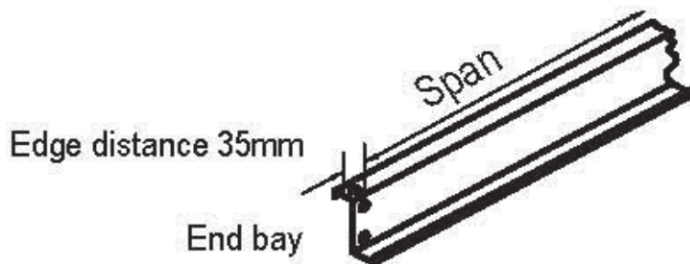
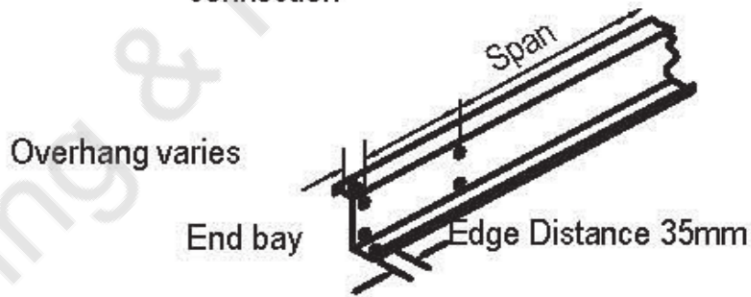
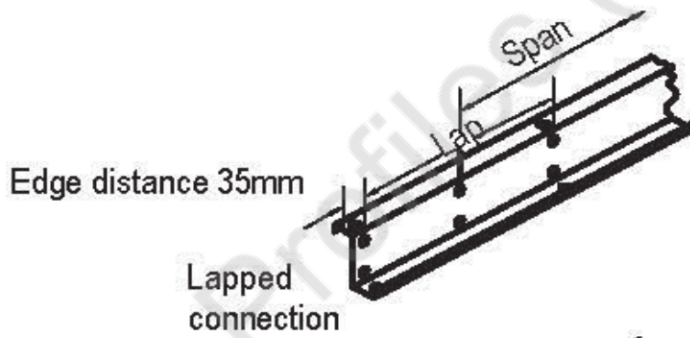

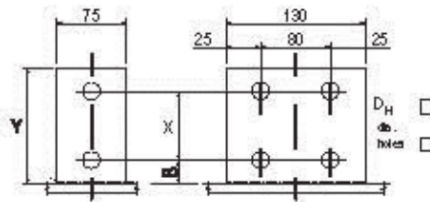

Cleat Nominal Dimensions (mm)

Nom.section size (mm)	X	B	Y	t (thickness)	Gap	DH
100	40	40	105	8	10	18
50	70	50	145	8	10	18
150	60	50	145	8	10	18
200	110	55	195	8	10	18
250	160	55	245	8	10	18
300	210	65	305	12	20	22

When using Zed sections with downturned lips, longer cleats are required to give clearance from the main support.

Fastening to cleats

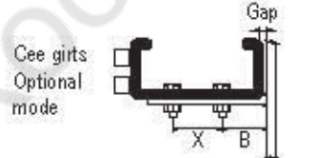
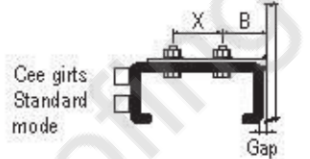
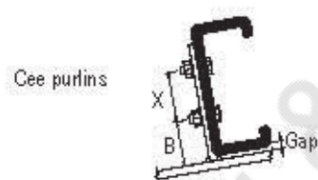
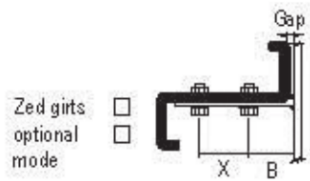
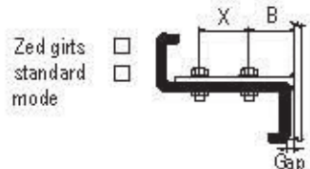
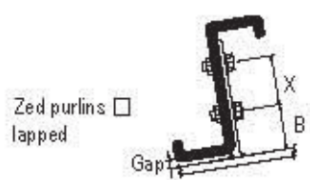

Location of bridging holes

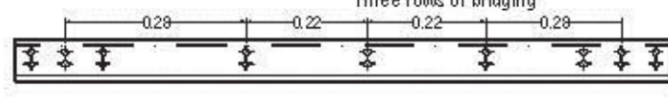
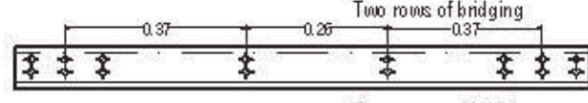
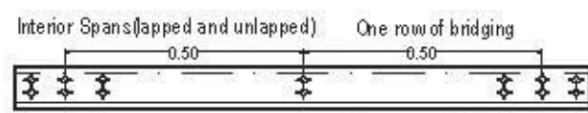
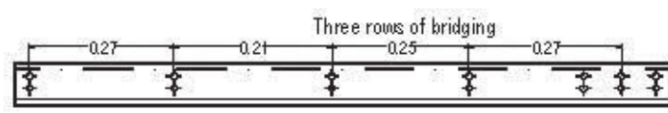
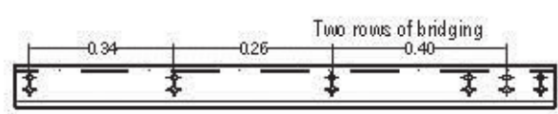
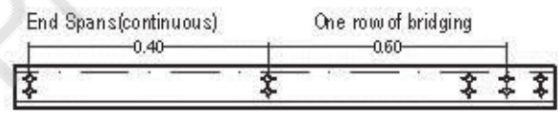
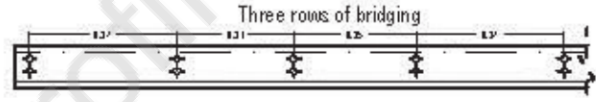
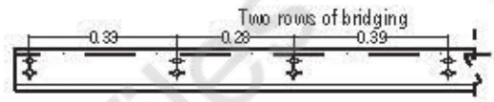
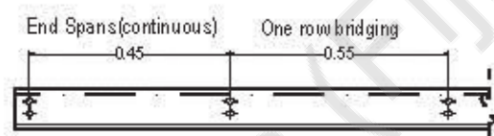
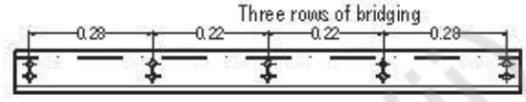
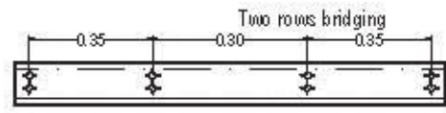
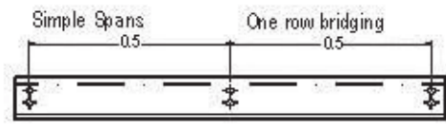

Note
To minimise the tendency of Cees and Zeds to rotate when used as purlins, it is necessary to have the top Flange pointing up the slope purlin orientation may be a Consideration in certain projects.

Design noted for capacity table

When determining a design, consideration should be given to load combinations for both strength and for serviceability.

Deflection

There are no specific rules governing acceptable deflections, though structural codes give guidance. You need to consider the specific requirements of any structure. It may be necessary to design for deflection under more than one load combination. See also Assumptions used in tables.

Axial loads

Where a section is not loaded to its full capacity in bending, it has a reserve of strength to carry some axial load. This reserve in purlins and girts can be used to transmit forces due to wind loading on end walls, or to resist forces due to bracing of wall and roof structures. Where required, the combined bending and axial load capacity should be calculated using AS/NZS 4600:1996 Cold-formed steel structures.

Point loads

The values in this publication assume uniformly distributed loading. However, in many applications (like the mounting of services and maintenance equipment) the loads applied to a structure are point loads. Thus, to use these tables for point loadings, the loads must be converted to equivalent distributed loads.

The table on the following page gives conversion formulae for loads on simple spans and lapped spans. They have been derived from commonly published moment and shear data and give conservative conversions.

For simple spans the formulae are straight forward. For non-continuous lapped spans, the formulae depend on the number of spans, the position of the span and the lapping ratio; thus, the worst-case configuration has been used, and the values may be safely used for end spans, interior spans and any lapping ratio greater than 10%.

Formulae for loads on continuous unlapped configurations, and for deflections in all configurations, are not given but may be derived similarly.

Symbols used in table for conversion of point loads

P = single point load (kN)

L = span (m)

a = larger distance from support (m)

b = smaller distance from support (m)

w = equivalent uniform load (kN/m)

Design optimisation

The capacity tables provide economical design solutions for most projects. Designs can be Optimised by varying:

- Material specifications
- Bolt specifications and number
- Non-standard purlin profile
- Reduced or enlarged end spans
- Span range
- Cantilevers at one or both ends
- Lap length
- Bridging quantity
- Load distribution

Bridging

The capacity tables give solutions for an equal number of rows of bridging in each span provision is made for 0, 1, 2 or 3 rows of bridging.

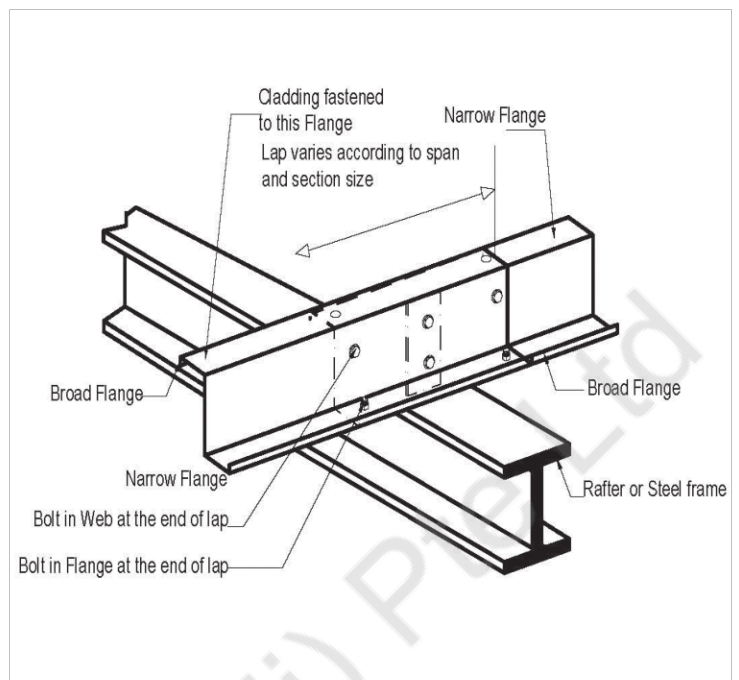
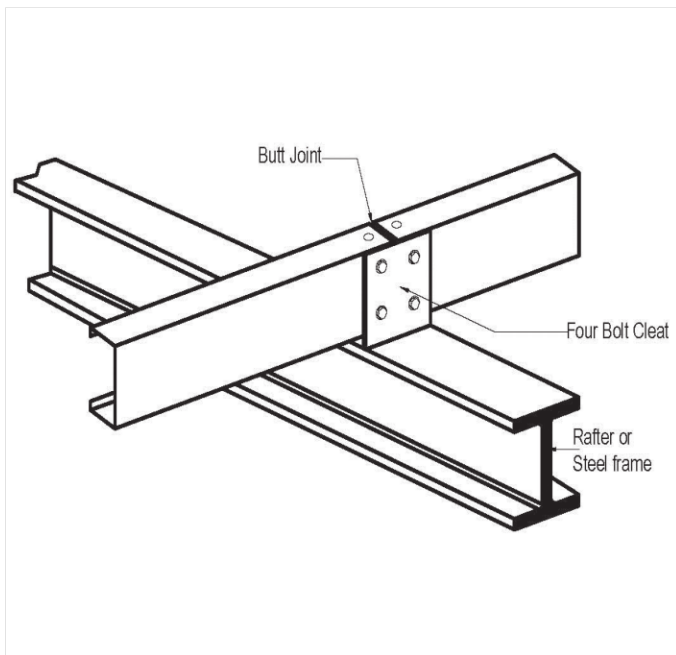

In practice it may be necessary to use at least one row of bridging in each span. We suggest that unbridging length be limited to 20 times the section depth.

Cleat connections

The capacity tables are based on the sections being fastened through the web to cleats (cleat connection) so that the load path is via the web of the sections. The connections may be single section thickness such as in end connections, or the internal support connection of continuous configurations. Connections with double section thickness occur at the internal support of lapped configurations. Each connection uses two bolts.

Cleatless connections

Fixing of purlins through the bottom flange of the purlin (cleatless connection) is used in some forms of construction. The purlin capacity tables should not be used for these types of connections. For these types of connections there are other design issues (both strength and serviceability) and construction issues that need to be considered. The numbers of bolts used are halved compared with the number used in conventional cleated connections.

Lapping





The structural lap at the interior supports of lapped configurations must be detailed to provide adequate structural continuity.

Each end of the lap must have one bolt through the flange furthest from the cladding, and one bolt through the webs near the flanges connected to the cladding.

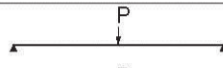
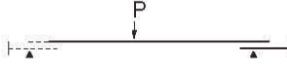
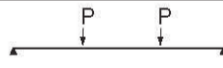
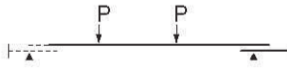
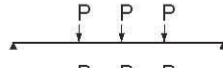
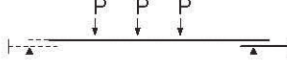
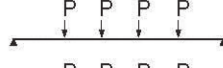
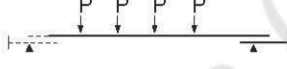

The nominal lap length is the distance between the bolt centres at the end of the laps. Laps vary in length with both section size and span as shown in the table below. In no situation must the lap be less than 10% of the span.

Conversion of point into equivalent uniform loads

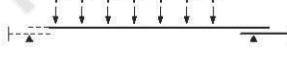
Symmetrical equidistant point loads

Loading Condition			Conversion formula
SINGLE LOAD	Simple		$w = 2P/L$
	Lapped		$w = 2.22P/L$
2 LOADS	Simple		$w = 2.67P/L$
	Lapped		$w = 3.16P/L$
3 LOADS	Simple		$w = 4P/L$
	Lapped		$w = 3.78P/L$
4 LOADS	Simple		$w = 4.80P/L$
	Lapped		$w = 5.12P/L$
5 LOADS	Simple		$w = 6P/L$
	Lapped		$w = 6.65P/L$
6 OR MORE LOADS	Simple		$w = 1.14NP/L$
	Lapped		$w = 1.22NP/L$

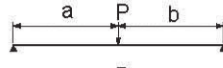
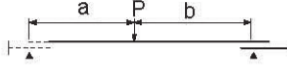
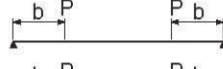
Single eccentric and two symmetrical point loads

Loading condition			conversion formula
SINGLE ECCENTRIC POINT LOAD	Simple		$w = 8abP/L^3$
	Lapped		$w = 17.76ab^2P/L^4$
2 ECCENTRIC POINT LOAD	Simple		$w = 8abP/L^2$
	Lapped		$w = 9.45b(2L-3b)P/L^3$

Intermediate values

Within a given bridging configuration, capacities for intermediate spans may be interpolated linearly.

Notes to capacity tables

1. Loads is assumed to be uniformly distributed (see also Point loads).
2. The capacities assume the use of approved RPFL sections, bridging system and bolts.
3. The column, Load for deflection span/150, is the load that will produce this deflection. It is not a design capacity.
4. All connections use RPFL purlin bolts grade 4.6, except for boldened capacities which require grade 8.8.
5. Forces acting to hold cladding against a structure are defined as inward. Forces acting to remove cladding from a structure are defined as outward

Lap lengths

Nominal section size (mm)	Span (mm)	Lap length (mm)
100	≤600	600
	0 >	900
	6000	
150,200,250	≤9000	900
	> 9000 ≤ 12000	1200
	> 12000*	1800
300	≤9000	900
	>12000	1200

* Load capacities for these spans are beyond the scope of this publication

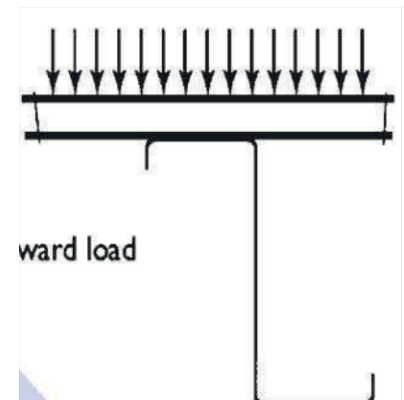
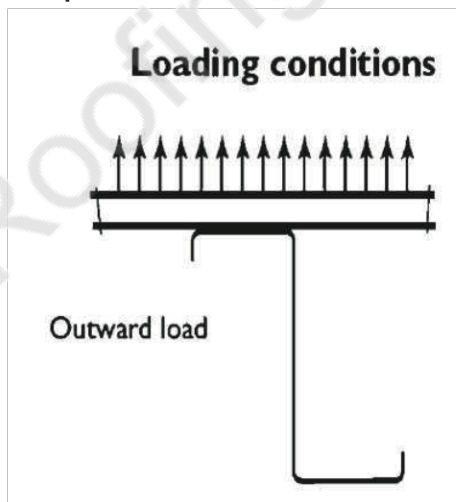

Limit state capacity tables

Single spans

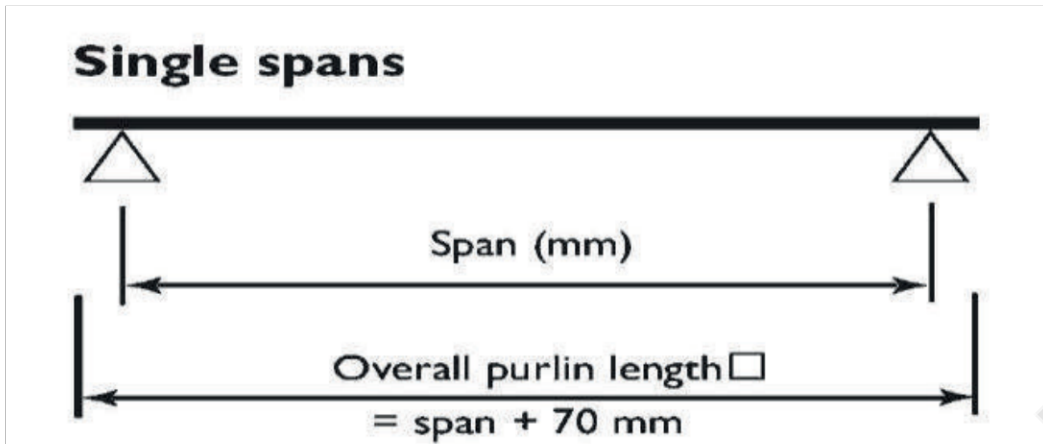

Single span: C/Z 10019(kN/m)

Span (mm)	Bridging >	0	IN		OUT			Load for deflection span/150
			1, 2, 3	0	1	2	3	
2100		8.44	8.79	7.37	8.79	8.79	8.79	7.34
2400		6.30	6.73	4.90	6.73	6.73	6.73	4.99
2700		4.88	5.32	3.35	5.32	5.32	5.32	3.50
3000		3.89	4.31	2.34	4.24	4.31	4.31	2.55
3300		3.17	3.56	1.70	3.32	3.56	3.56	1.92
3600		2.63	2.99	1.27	2.61	2.99	2.99	1.48
3900		2.22	2.55	0.97	2.08	2.55	2.55	1.16
4200		1.89	2.20	0.76	1.65	2.20	2.20	0.93
4500		1.64	1.91	0.61	1.32	1.87	1.91	0.76
4800		1.43	1.68	0.50	1.06	1.58	1.68	0.62
5100		1.26	1.49	0.41	0.86	1.34	1.49	0.52
5400		1.11	1.33		0.71	1.14	1.33	0.44
5700		0.99	1.19		0.58	0.98	1.19	0.37
6000		0.89	1.08		0.49	0.84	1.05	0.32
6300		0.81	0.98		0.41	0.71	0.93	0.28
6600		0.73	0.89			0.61	0.82	0.24
6900		0.67	0.81			0.53	0.72	0.21
7200		0.61	0.75			0.46	0.64	0.19
7500		0.56	0.56				0.57	0.16

Bold capacities require grade 8.8 purlin bolts. Values above horizontal line in body of table are governed by the strength of the grade 8.8 bolt. IN = Inward load capacity. OUT = Outward load capacity L/150 = load for deflection span/150. See also: Design notes for capacity tables.

Limit state capacity tables

Single spans

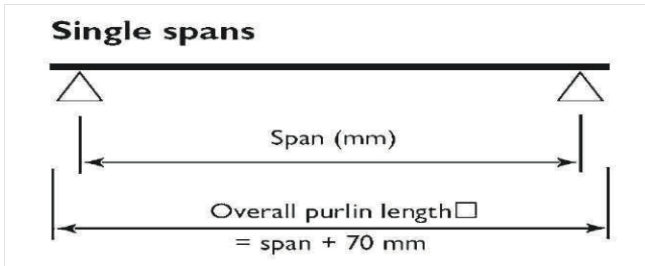

Single span: C/Z 15015 (kN/m)

Bridging >	Span (mm)	IN			OUT			Load for deflection
		0	1,2,3	0	1	2	3	span/150
	2100	11.12	11.12	11.12	11.12	11.12	11.12	15.62
	2400	8.51	8.51	8.17	8.51	8.51	8.51	10.50
	2700	6.73	6.73	5.79	6.73	6.73	6.73	7.48
	3000	5.41	5.45	4.02	5.45	5.45	5.45	5.52
	3300	4.39	4.50	3.00	4.50	4.50	4.50	4.19
	3600	3.64	3.78	2.29	3.78	3.78	3.78	3.27
	3900	3.06	3.22	1.75	3.22	3.22	3.22	2.61
	4200	2.61	2.78	1.36	2.73	2.78	2.78	2.12
	4500	2.25	2.42	1.06	2.25	2.42	2.42	1.74
	4800	1.96	2.13	0.84	1.85	2.13	2.13	1.45
	5100	1.72	1.89	0.67	1.52	1.89	1.89	1.21
	5400	1.52	1.68	0.55	1.23	1.68	1.68	1.03
	5700	1.36	1.51	0.45	1.04	1.51	1.51	0.88
	6000	1.21	1.36		0.89	1.36	1.36	0.76
	6300	1.09	1.24		0.76	1.19	1.24	0.66
	6600	0.98	1.13		0.65	1.05	1.13	0.57
	6900	0.89	1.03		0.56	0.92	1.03	0.50
	7200	0.82	0.95		0.48	0.8	0.95	0.44
	7500	0.75	0.87		0.42	0.70	0.87	0.39

Single span: C/Z 15019 (kN/m)

Single span: C/Z 15024 (kN/m)

Bridging >	Span (mm)	IN							Load for deflection span/150	OUT							Load for deflection span/150
		0	1	2,3	0	1	2	3		0	1	2	3				
	3000	6.79	7.68	7.68	5.67	7.68	7.68	7.68	7.33	8.82	10.82	10.82	7.71	10.82	10.82	10.82	9.58
	3300	5.51	6.35	6.35	4.12	6.35	6.35	6.35	5.59	7.04	8.94	8.94	5.54	8.94	8.94	8.94	7.22
	3600	4.56	5.33	5.33	3.09	5.33	5.33	5.33	4.32	5.70	7.52	7.52	4.09	7.52	7.52	7.52	5.56
	3900	3.82	4.55	4.55	2.32	4.37	4.55	4.55	3.42	4.71	6.4	6.40	3.09	6.20	6.40	6.40	4.37
	4200	3.24	3.92	3.92	1.78	3.62	3.92	3.92	2.76	3.95	5.52	5.52	2.39	5.09	5.52	5.52	3.50
	4500	2.78	3.41	3.41	1.39	3.02	3.41	3.41	2.26	3.36	4.81	4.81	1.88	4.22	4.81	4.81	2.85
	4800	2.41	3.00	3.00	1.11	2.53	3.00	3.00	1.86	2.89	4.23	4.23	1.51	3.52	4.23	4.23	2.35
	5100	2.11	2.66	2.66	0.90	2.10	2.66	2.66	1.55	2.52	3.74	3.74	1.23	2.93	3.74	3.74	1.96
	5400	1.87	2.37	2.37	0.73	1.75	2.35	2.37	1.31	2.21	3.34	3.34	1.01	2.40	3.34	3.34	1.65
	5700	1.66	2.13	2.13	0.61	1.45	2.05	2.13	1.11	1.95	2.98	3.00	0.84	1.98	2.91	3.00	1.40
	6000	1.48	1.92	1.92	0.51	1.22	1.80	1.92	0.95	1.74	2.66	2.71	0.71	1.65	2.54	2.71	1.20
	6300	1.33	1.74	1.74	0.43	1.04	1.59	1.74	0.82	1.56	2.39	2.45	0.61	1.39	2.23	2.45	1.04
	6600	1.20	1.59	1.59		0.88	1.41	1.59	0.72	1.41	2.16	2.24	0.52	1.18	1.97	2.24	0.90
	6900	1.09	1.45	1.45		0.75	1.25	1.45	0.63	1.27	1.96	2.05	0.45	1.01	1.74	2.05	0.79
	7200	0.99	1.33	1.33		0.64	1.10	1.32	0.55	1.16	1.79	1.88		0.86	1.54	1.88	0.70
	7500	0.91	1.22	1.23		0.55	0.97	1.20	0.49	1.06	1.64	1.73		0.75	1.35	1.70	0.62
	7800	0.83	1.12	1.14		0.48	0.86	1.08	0.43	0.97	1.50	1.60		0.65	1.18	1.53	0.55
	8100	0.77	1.04	1.05		0.42	0.75	0.98	0.39	0.89	1.38	1.48		0.57	1.03	1.39	0.49

Bold capacities require grade 8.8 purlin bolts. Values above horizontal line in body of table are governed by the strength of the grade 8.8 bolt. IN = Inward load capacity. OUT = Outward load capacity L/150 = load for deflection span/150. See also: Design notes for capacity tables.

Limit state capacity tables

Single spans

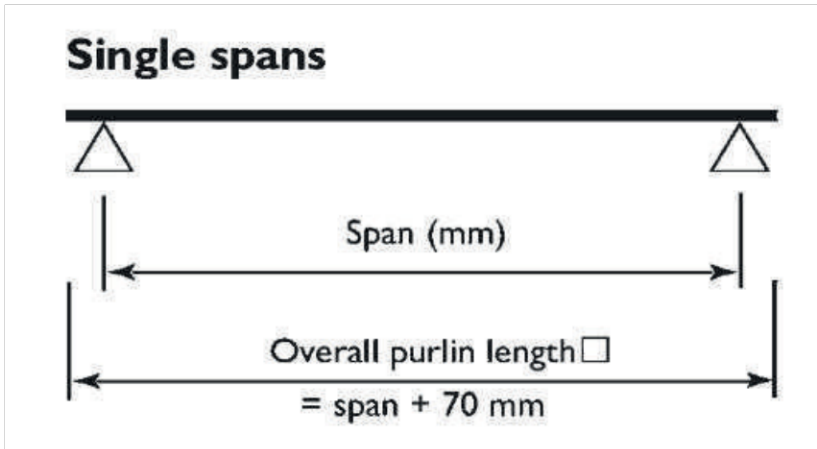

Span (mm)	Single span: C/Z 20015 (kN/m)								Single span: C/Z 20019 (kN/m)								Single span: C/Z 20024 (kN/m)							
	IN				Load for deflection on span/150	OUT				IN				Load for deflection on span/150	OUT				Load for deflection on span/150					
	0	1,2,3	0	1		2	3	0	1,2,3	0	1	2	3		0	1	2	3						
3000	7.38	7.38	7.28	7.38	7.38	7.38	7.38	10.60	10.52	11.25	10.56	11.25	11.25	1.125	15.10	13.70	16.35	16.35	16.35	14.57	16.35	16.35	16.35	19.93
3300	6.10	6.10	5.47	6.10	6.10	6.10	6.10	7.96	8.38	9.30	7.83	9.30	9.30	9.30	11.42	10.79	13.52	13.52	13.52	11.11	13.52	13.52	13.52	15.19
3600	5.13	5.13	4.10	5.13	5.13	5.13	5.13	6.28	6.78	7.81	5.77	7.81	7.81	7.81	8.89	8.65	11.36	11.36	11.36	8.32	11.36	11.36	11.36	11.89
3900	4.33	4.37	3.13	4.37	4.37	4.37	4.37	5.07	5.59	6.66	4.50	6.66	6.66	6.66	7.06	7.08	9.68	9.68	9.68	6.38	9.68	9.68	9.68	9.49
4200	3.69	3.77	2.44	3.77	3.77	3.77	3.77	4.15	4.54	5.74	3.57	5.74	5.74	5.74	5.70	5.91	8.34	8.34	8.34	4.95	8.34	8.34	8.34	7.67
4500	3.17	3.28	1.86	3.28	3.28	3.28	3.28	3.45	3.88	5.00	2.84	5.00	5.00	5.00	4.67	5.00	7.27	7.27	7.27	3.86	7.23	7.27	7.27	6.27
4800	2.75	2.88	1.51	2.88	2.88	2.88	2.88	2.88	3.35	4.39	2.27	4.39	4.39	4.39	3.88	4.29	6.39	6.39	6.39	3.06	6.14	6.39	6.39	5.19
5100	2.41	2.56	1.25	2.56	2.56	2.56	2.56	2.42	2.92	3.89	1.84	3.84	3.89	3.89	3.27	3.72	5.66	5.66	5.66	2.46	5.26	5.66	5.66	4.35
5400	2.13	2.28	1.04	2.24	2.28	2.28	2.28	2.05	2.57	3.47	1.51	3.27	3.47	3.47	2.78	3.26	5.05	5.05	5.05	2.00	4.53	5.05	5.05	3.69
5700	1.89	2.05	0.87	1.92	2.05	2.05	2.05	1.75	2.27	3.12	1.24	2.77	3.12	3.12	2.39	2.88	4.53	4.53	4.53	1.65	3.91	4.53	4.53	3.15
6000	1.68	1.85	0.72	1.62	1.85	1.85	1.85	1.51	2.03	2.81	1.03	2.26	2.81	2.81	2.07	2.55	4.05	4.09	4.09	1.38	3.35	4.09	4.09	2.70
6300	1.51	1.67	0.61	1.38	1.67	1.67	1.67	1.31	1.82	2.55	0.86	1.94	2.55	2.55	1.80	2.28	3.64	3.71	3.71	1.16	2.84	3.71	3.71	2.34
6600	1.36	1.53	0.52	1.18	1.53	1.53	1.53	1.15	1.64	2.32	0.72	1.68	2.32	2.32	1.57	2.04	3.28	3.38	3.38	0.98	2.43	3.36	3.38	2.03
6900	1.23	1.40	0.44	1.01	1.40	1.40	1.40	1.01	1.49	2.13	0.62	1.46	2.13	2.13	1.38	1.84	2.98	3.09	3.09	0.84	2.09	3.01	3.09	1.78
7200	1.12	1.28	0.87	0.87	1.28	1.28	0.89	0.89	1.36	1.95	0.53	1.28	1.95	1.95	1.22	1.67	2.71	2.84	2.84	0.72	1.82	2.70	2.84	1.57
7500	1.03	1.18	0.76	1.18	1.18	1.18	0.79	0.79	1.24	1.80	0.46	1.12	1.78	1.80	1.08	1.52	2.48	2.62	2.62	0.63	1.57	2.43	2.62	1.38
7800	0.94	1.09	0.64	1.09	1.09	1.09	0.71	0.71	1.14	1.66	0.40	0.99	1.59	1.66	0.96	1.39	2.27	2.42	2.42	0.55	1.36	2.20	2.42	1.23
8100	0.87	1.01	0.56	0.98	1.01	1.01	0.64	0.64	1.05	1.54	0.86	1.43	1.54	1.54	0.86	1.28	2.09	2.24	2.24	0.48	1.19	1.99	2.24	1.10
8400	0.80	0.94	0.50	0.88	0.94	0.94	0.58	0.58	0.97	1.44	0.76	1.27	1.44	1.44	0.77	1.18	1.93	2.09	2.09	0.42	1.04	1.80	2.09	0.99
8700	0.74	0.88	0.45	0.79	0.88	0.88	0.52	0.52	0.90	1.34	0.67	1.13	1.34	1.34	0.70	1.09	1.79	1.95	1.95	0.91	1.62	1.95	1.95	0.89
9000	0.69	0.82	0.40	0.70	0.82	0.82	0.47	0.47	0.84	1.25	0.60	0.98	1.25	1.25	0.63	1.01	1.66	1.82	1.82	0.81	1.45	1.79	1.79	0.80
9300	0.64	0.77	0.63	0.77	0.77	0.77	0.43	0.43	0.78	1.17	0.53	0.89	1.17	1.17	0.58	0.93	1.55	1.70	1.70	0.72	1.30	1.65	1.65	0.73
9600	0.60	0.72	0.56	0.72	0.72	0.72	0.39	0.39	0.73	1.10	0.47	0.80	1.10	1.10	0.52	0.87	1.44	1.60	1.60	0.64	1.17	1.52	1.52	0.66
9900	0.56	0.68	0.51	0.68	0.68	0.68	0.36	0.36	0.68	1.03	0.42	0.73	1.03	1.03	0.48	0.81	1.35	1.49	1.50	0.57	1.05	1.41	1.41	0.60
10200	0.53	0.64	0.46	0.64	0.64	0.64	0.33	0.33	0.64	0.97	0.66	0.95	0.66	0.66	0.44	0.76	1.27	1.40	1.42	0.51	0.95	1.30	1.30	0.55
10500	0.49	0.60	0.42	0.60	0.60	0.60	0.31	0.31	0.60	0.92	0.61	0.87	0.61	0.61	0.40	0.71	1.19	1.31	1.34	0.46	0.86	1.21	1.21	0.50
10800	0.46	0.57	0.55	0.57	0.57	0.57	0.28	0.28	0.56	0.87	0.55	0.80	0.55	0.55	0.37	0.67	1.12	1.23	1.26	0.41	0.78	1.12	1.12	0.46
11100	0.44	0.54	0.51	0.54	0.54	0.54	0.26	0.26	0.53	0.82	0.51	0.74	0.51	0.51	0.34	0.63	1.06	1.16	1.20	0.71	1.04	1.04	1.04	0.43
11400	0.41	0.51	0.47	0.51	0.51	0.51	0.24	0.24	0.50	0.78	0.47	0.68	0.47	0.47	0.31	0.59	1.00	1.09	1.13	0.64	0.96	0.96	0.96	0.39
11700	0.39	0.49	0.43	0.49	0.49	0.49	0.22	0.22	0.48	0.74	0.43	0.62	0.43	0.43	0.29	0.56	0.94	1.03	1.08	0.59	0.89	0.89	0.89	0.37
12000	0.37	0.46	0.40	0.46	0.46	0.46	0.21	0.21	0.45	0.70	0.55	0.62	0.55	0.55	0.27	0.53	0.89	0.98	1.02	0.53	0.82	0.82	0.82	0.34

Bold capacities require grade 8.8 purlin bolts. Values above horizontal line in body of table are governed by the strength of the grade 8.8 bolt. IN = Inward load capacity. OUT = Outward load capacity L/150 = load for deflection span/150. See also: Design notes for capacity tables.

Limit state capacity tables

Single spans

Single spans

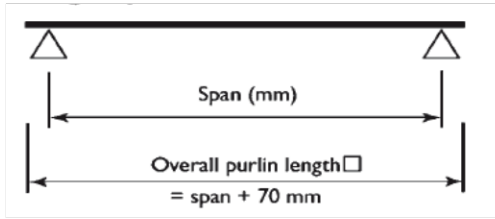

Single span: C/Z 25019 (kN/m)

Single span: C/Z 25024 (kN/m)

Span (mm)	Bridging >	Single span: C/Z 25019 (kN/m)							Single span: C/Z 25024 (kN/m)							
		IN			OUT				Load for deflection span/150	OUT			OUT			
0	1,2,3	0	1	2	3	0	1	2,3		0	1	2	3			
3000		13.83	14.28	14.17	14.28	14.28	14.28	24.52	17.71	20.96	20.96	19.42	20.96	20.96	20.96	33.82
3300		10.90	11.8	10.06	11.8	11.8	11.80	18.42	13.78	17.32	17.32	14.58	17.32	17.32	17.32	25.41
3600		8.51	9.92	7.64	9.92	9.92	9.92	14.19	11.02	14.56	14.56	10.84	14.56	14.56	14.56	19.57
3900		7.04	8.45	5.92	8.45	8.45	8.45	11.16	9.01	12.40	12.40	8.29	12.40	12.40	12.40	15.46
4200		5.91	7.28	4.67	7.28	7.28	7.28	9.07	7.50	10.69	10.69	6.39	10.69	10.69	10.69	12.53
4500		5.04	6.35	3.69	6.35	6.35	6.35	7.54	6.34	9.32	9.32	4.97	9.32	9.32	9.32	10.30
4800		4.34	5.58	2.936	5.58	5.58	5.58	6.35	5.43	8.19	8.19	3.93	8.19	8.19	8.19	8.58
5100		3.78	4.94	2.37	4.94	4.94	4.94	5.38	4.71	7.25	7.25	3.15	7.03	7.25	7.25	7.22
5400		3.32	4.41	1.94	4.39	4.41	4.41	4.56	4.11	6.47	6.47	2.55	6.03	6.47	6.47	6.11
5700		2.94	3.96	1.58	3.68	3.96	3.96	3.90	3.61	5.81	5.81	2.10	5.16	5.81	5.81	5.21
6000		2.62	3.57	1.31	3.01	3.57	3.57	3.37	3.19	5.24	5.24	1.74	4.38	5.24	5.24	4.48
6300		2.35	3.24	1.09	2.58	3.24	3.24	2.93	2.85	4.75	4.75	1.46	3.70	4.75	4.75	3.89
6600		2.12	2.95	0.92	2.22	2.95	2.95	2.57	2.55	4.33	4.33	1.23	3.16	4.33	4.33	3.40
6900		1.92	2.70	0.78	1.92	2.70	2.70	2.26	2.3	3.96	3.96	1.05	2.72	3.96	3.96	2.99
7200		1.75	2.48	0.67	1.68	2.48	2.48	2.00	2.08	3.60	3.64	0.90	2.35	3.62	3.64	2.64
7500		1.60	2.28	0.57	1.47	2.28	2.28	1.78	1.90	3.29	3.35	0.78	2.03	3.25	3.35	2.34
7800		1.46	2.11	0.50	1.29	2.11	2.11	1.60	1.73	3.01	3.10	0.68	1.75	2.93	3.10	2.08
8100		1.35	1.96	0.43	1.12	1.91	1.96	1.43	1.59	2.77	2.88	0.59	1.53	2.64	2.88	1.86
8400		1.24	1.82		0.98	1.69	1.82	1.29	1.46	2.56	2.67	0.52	1.33	2.37	2.67	1.67
8700		1.15	1.70		0.87	1.46	1.70	1.16	1.35	2.36	2.49	0.46	1.17	2.12	2.49	1.50
9000		1.07	1.59		0.77	1.31	1.59	1.05	1.25	2.19	2.33	0.41	1.03	1.89	2.33	1.36
9300		1.00	1.49		0.69	1.18	1.49	0.95	1.16	2.04	2.18		0.91	1.69	2.18	1.23
9600		0.93	1.39		0.61	1.06	1.39	0.87	1.08	1.90	2.05		0.81	1.52	2.04	1.12
9900		0.87	1.31		0.54	0.96	1.31	0.79	1.01	1.78	1.93		0.72	1.36	1.88	1.02
10200		0.82	1.24		0.49	0.87	1.24	0.73	0.94	1.67	1.81		0.65	1.23	1.74	0.93
10500		0.77	1.17		0.44	0.80	1.17	0.67	0.88	1.56	1.71		0.58	1.12	1.61	0.85
10800		0.72	1.10			0.73	1.07	0.61	0.83	1.47	1.62		0.52	1.01	1.49	0.78
11100		0.68	1.04			0.66	0.98	0.57	0.78	1.38	1.53		0.47	0.92	1.37	0.72
11400		0.64	0.99			0.61	0.9	0.53	0.74	1.30	1.45		0.43	0.83	1.26	0.67
11700		0.61	0.94			0.55	0.80	0.49	0.69	1.23	1.38			0.75	1.16	0.62
12000		0.58	0.89			0.5	0.74	0.45	0.66	1.16	1.30			0.69	1.07	0.57

Bold capacities require grade 8.8 purlin bolts. Values above horizontal line in body of table are governed by the strength of the grade 8.8 bolt. IN = Inward load capacity. OUT = Outward load capacity L/150 = load for deflection span/150. See also: Design notes for capacity tables.

Limit state capacity tables

Single spans

Single spans

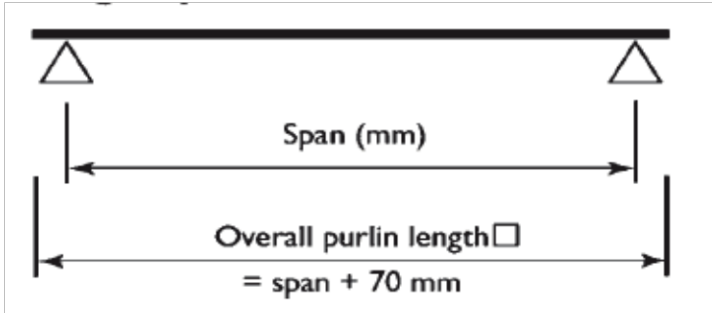

Single span: C/Z 30024 (kN/m)

Single span: C/Z 30030 (kN/m)

Bridging > span (mm)	IN				OUT				Load for deflection span/150	IN				OUT				Load for deflection span/150
	0	1	2	3	0	1	2	3		0	1	2	3	0	1	2	3	
6000	4.50	7.20	7.20	7.20	3.84	7.20	7.20	7.20	7.44	5.21	10.26	10.26	10.26	5.04	10.26	10.26	10.26	9.95
6300	3.99	6.53	6.53	6.53	3.21	6.53	6.53	6.53	6.46	4.59	9.31	9.31	9.31	4.22	9.11	9.31	9.31	8.64
6600	3.57	5.95	5.95	5.95	2.70	5.93	5.95	5.95	5.65	4.06	8.46	8.48	8.48	3.56	8.09	8.48	8.48	7.56
6900	3.21	5.44	5.44	5.44	2.29	5.24	5.44	5.44	4.97	3.63	7.63	7.76	7.76	3.03	7.21	7.76	7.76	6.66
7200	2.89	5.00	5.00	5.00	1.96	4.61	5.00	5.00	4.40	3.25	6.91	7.13	7.13	2.59	6.44	7.13	7.13	5.86
7500	2.61	4.61	4.61	4.61	1.68	4.03	4.61	4.61	3.93	2.94	6.29	6.57	6.57	2.23	5.74	6.57	6.57	5.18
7800	2.37	4.26	4.26	4.26	1.45	3.54	4.26	4.26	3.52	2.66	5.74	6.07	6.07	1.94	5.05	6.07	6.07	4.16
8100	2.17	3.95	3.95	3.95	1.27	3.08	3.95	3.95	3.17	2.43	5.26	5.63	5.63	1.69	4.47	5.63	5.63	4.12
8400	1.99	3.67	3.67	3.67	1.11	2.75	3.67	3.67	2.86	2.22	4.83	5.24	5.24	1.48	3.95	5.24	5.24	3.69
8700	1.83	3.40	3.42	3.42	0.97	2.47	3.42	3.42	2.60	2.04	4.45	4.88	4.88	1.30	3.48	4.88	4.88	3.32
9000	1.68	3.14	3.20	3.20	0.86	2.22	3.20	3.20	2.35	1.88	4.11	4.56	4.56	1.15	3.07	4.53	4.56	3.00
9300	1.56	2.91	3.00	3.00	0.76	2.01	3.00	3.00	2.14	1.73	3.80	4.27	4.27	1.02	2.73	4.17	4.27	2.72
9600	1.45	2.70	2.81	2.81	0.68	1.80	2.81	2.81	1.95	1.61	3.52	4.01	4.01	0.91	2.43	3.85	4.01	2.47
9900	1.35	2.51	2.64	2.64	0.61	1.62	2.60	2.64	1.79	1.49	3.26	3.77	3.77	0.82	2.17	3.56	3.77	2.25
10200	1.25	2.34	2.49	2.49	0.54	1.47	2.39	2.49	1.64	1.39	3.02	3.55	3.55	0.74	1.94	3.29	3.55	2.06
10500	1.17	2.18	2.35	2.35	0.49	1.32	2.19	2.35	1.50	1.30	2.80	3.35	3.35	0.67	1.74	3.05	3.35	1.89
10800	1.10	2.04	2.22	2.22	0.44	1.18	2.00	2.22	1.38	1.22	2.61	3.16	3.17	0.60	1.57	2.82	3.17	1.74
11100	1.03	1.91	2.10	2.10	0.40	1.07	1.83	2.10	1.27	1.14	2.44	2.97	3.00	0.55	1.42	2.60	3.00	1.60
11400	0.97	1.79	1.99	1.99	0.37	0.97	1.67	1.99	1.18	1.07	2.28	2.79	2.84	0.50	1.29	2.39	2.84	1.48
11700	0.91	1.68	1.89	1.89	0.34	0.88	1.53	1.89	1.09	1.01	2.14	2.63	2.70	0.46	1.17	2.19	2.70	1.37
12000	0.86	1.58	1.80	1.80	0.31	0.80	1.39	1.80	1.01	0.95	2.01	2.48	2.57	0.42	1.06	2.02	2.55	1.27

SECTION BELOW EXCEED THE NORMAL DELIVERY LENGTH OF 12000 MM

12300	0.81	1.48	1.71	1.71	0.73	1.29	1.71	0.94	0.90	1.89	2.34	2.44	0.97	1.86	2.40	1.18
12600	0.77	1.40	1.63	1.63	0.66	1.20	1.63	0.87	0.85	1.78	2.21	2.33	0.89	1.70	2.26	1.09
12900	0.73	1.32	1.56	1.56	0.61	1.11	1.56	0.81	0.81	1.67	2.10	2.22	0.81	1.56	2.12	1.02
13200	0.69	1.25	1.49	1.49	0.56	1.04	1.46	0.76	0.76	1.58	1.99	2.12	0.75	1.44	2.00	0.95
13500	0.66	1.19	1.42	1.42	0.51	0.97	1.37	0.71	0.73	1.49	1.89	2.03	0.69	1.32	1.89	0.89
13800	0.63	1.13	1.36	1.36	0.47	0.90	1.29	0.66	0.69	1.41	1.79	1.94	0.63	1.22	1.78	0.83
14100	0.60	1.07	1.30	1.30	0.43	0.84	1.21	0.62	0.66	1.30	1.71	1.86	0.58	1.13	1.68	0.78
14400	0.57	1.02	1.25	1.25	0.40	0.78	1.13	0.58	0.63	1.27	1.62	1.78	0.54	1.04	1.59	0.73
14700	0.50	0.97	1.19	1.20		0.73	1.05	0.55	0.60	1.20	1.55	1.71	0.50	0.97	1.50	0.69
15000	0.52	0.91	1.13	1.15		0.68	0.98	0.52	0.57	1.15	1.48	1.63	0.47	0.90	1.40	0.65
15300	0.50	0.87	1.08	1.11		0.63	0.92	0.49	0.55	1.09	1.41	1.56	0.43	0.83	1.32	0.61
15600	0.48	0.83	1.03	1.07		0.59	0.86	0.46	0.52	1.04	1.35	1.49	0.40	0.78	1.23	0.58
15900	0.46	0.80	0.99	1.03		0.54	0.80	0.43	0.5	0.99	1.29	1.43	0.72	1.16	1.16	0.54
16200	0.44	0.77	0.95	0.99		0.51	0.75	0.41	0.48	0.95	1.23	1.37	0.68	1.09	1.09	0.51
16500	0.42	0.73	0.91	0.95		0.47	0.71	0.39	0.46	0.91	1.17	1.31	0.63	1.02	1.02	0.49
16800	0.40	0.71	0.87	0.92		0.44	0.67	0.37	0.44	0.87	1.12	1.26	0.59	0.96	0.96	0.46
17100		0.68	0.84	0.89		0.41	0.64	0.35	0.43	0.83	1.07	1.21	0.55	0.90	0.90	0.44
17400		0.65	0.8	0.86			0.60	0.33	0.41	0.80	1.03	1.16	0.52	0.84	0.84	0.42
17700		0.63	0.77	0.83			0.57	0.31	0.40	0.76	0.98	1.11	0.49	0.79	0.79	0.39
18000		0.60	0.74	0.80			0.54	0.30		0.73	0.94	1.07	0.46	0.75	0.75	0.38

Limit state capacity tables

Double continuous spans

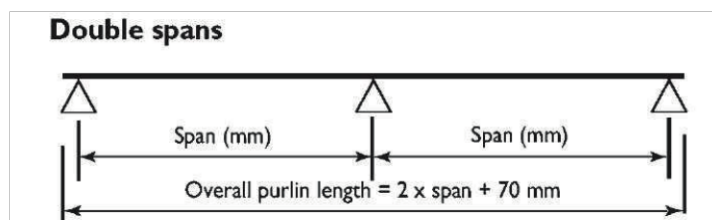

Double span: C/Z 10019 (kN/m)

Span (mm)	Bridging >	IN		OUT				Load for deflection span/150
		0	1	0	1	2	3	
2100		8.68	8.79	8.79	8.79	8.79	8.79	17.31
2400		6.50	6.73	6.73	6.73	6.73	6.73	11.59
2700		5.02	5.32	5.32	5.32	5.32	5.32	8.14
3000		3.97	4.31	4.31	4.31	4.31	4.31	5.94
3300		3.22	3.56	3.56	3.56	3.56	3.56	4.46
3600		2.66	2.99	2.99	2.99	2.99	2.99	3.44
3900		2.22	2.55	2.28	2.55	2.55	2.55	2.72
4200		1.89	2.20	1.87	2.20	2.20	2.20	2.18
4500		1.62	1.91	1.55	1.91	1.91	1.91	1.78
4800		1.40	1.68	1.28	1.67	1.68	1.68	1.47
5100		1.22	1.49	1.07	1.45	1.49	1.49	1.23
5400		1.07	1.33	0.90	1.25	1.33	1.33	1.05
5700		0.94	1.19	0.76	1.08	1.19	1.19	0.89
6000		0.83	1.08	0.65	0.94	1.08	1.08	0.77
SECTION BELOW EXCEED THE NORMAL DELIVERY LENGTH OF 12000 MM								
6300		0.74	0.98	0.56	0.82	0.98	0.98	0.66
6600		0.66	0.89	0.48	0.72	0.89	0.89	0.58
6900		0.59	0.81	0.42	0.63	0.80	0.81	0.50
7200		0.54	0.75		0.55	0.72	0.75	0.44
7500		0.48	0.69		0.49	0.60	0.69	0.39

Limit state capacity tables

Double continuous spans

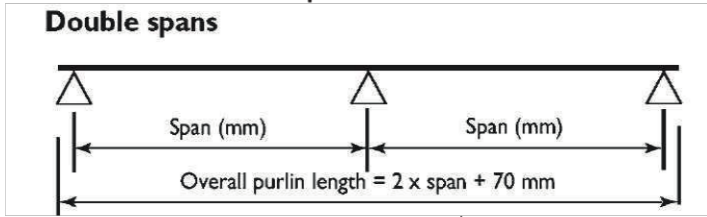

Double span: Z/C 15015 (kN/m)

Bridging >	Span (mm)	Load for deflection span/150	IN		OUT			Load for deflection span/150
			0	1,2,3	0	1	2,3	
	2100	27.65	10.29	10.29	10.29	10.29	10.29	37.56
	2400	18.52	8.28	8.28	8.28	8.28	8.28	25.16
	2700	13.01	6.73	6.73	6.73	6.73	6.73	17.67
	3000	9.48	5.45	5.45	5.45	5.45	5.45	12.88
	3300	7.12	4.48	4.50	4.50	4.50	4.50	9.68
	3600	5.49	3.69	3.78	3.78	3.78	3.78	7.46
	3900	4.32	3.09	3.22	3.22	3.22	3.22	5.86
	4200	3.46	2.62	2.78	2.78	2.78	2.78	4.70
	4500	2.81	2.24	2.42	2.40	2.42	2.42	3.82
	4800	2.32	1.94	2.13	2.02	2.13	2.13	3.15
	5100	1.93	1.69	1.89	1.71	1.89	1.89	2.62
	5400	1.63	1.48	1.68	1.44	1.68	1.68	2.21
	5700	1.41	1.30	1.51	1.21	1.51	1.51	1.88
	6000	1.23	1.15	1.36	1.01	1.36	1.36	1.62
SECTIONS BELOW EXCEED THE NORMAL DELIVERY LENGTH OF 12000 mm								
	6300	1.07	1.02	1.24	0.87	1.24	1.24	1.41
	6600	0.95	0.91	1.13	0.76	1.13	1.13	1.23
	6900	0.84	0.80	1.03	0.67	1.00	1.03	1.09
	7200	0.75	0.72	0.95	0.59	0.89	0.95	0.96
	7500	0.66	0.65	0.87	0.52	0.80	0.87	0.85
	7800	0.59	0.59	0.81	0.45	0.71	0.81	0.76
	8100	0.53	0.54	0.75	0.40	0.63	0.75	0.68

Double span: Z/C 15019 (kN/m)

Double span: Z/C 15024 (kN/m)

Bridging >	Span (mm)	IN			OUT				Load for deflection span/150	OUT				Load for deflection span/150			
		0	1	2,3	0	1	2	3		0	1	2	3				
	3000	7.01	7.68	7.68	7.68	7.68	7.68	7.68	16.81	9.34	10.82	10.82	10.82	10.82	10.82	10.82	22.42
	3300	5.67	6.35	6.35	6.35	6.35	6.35	6.35	12.63	7.50	8.94	8.94	8.94	8.94	8.94	8.94	16.84
	3600	4.68	5.33	5.33	5.33	5.33	5.33	5.33	9.73	6.13	7.52	7.52	7.52	7.52	7.52	7.52	12.97
	3900	3.92	4.55	4.55	4.51	4.55	4.55	4.55	7.65	5.07	6.40	6.40	6.40	6.40	6.40	6.40	10.20
	4200	3.32	3.92	3.92	3.76	3.92	3.92	3.92	6.13	4.23	5.52	5.52	5.30	5.52	5.52	5.52	8.17
	4500	2.83	3.41	3.41	3.17	3.41	3.41	3.41	4.98	3.57	4.81	4.81	4.43	4.81	4.81	4.81	6.64
	4800	2.44	3.00	3.00	2.69	3.00	3.00	3.00	4.10	3.05	4.23	4.23	3.74	4.23	4.23	4.23	5.47
	5100	2.12	2.66	2.66	2.30	2.66	2.66	2.66	3.42	2.64	3.74	3.74	3.18	3.74	3.74	3.74	4.56
	5400	1.86	2.37	2.37	1.96	2.37	2.37	2.37	2.88	2.30	3.34	3.34	2.72	3.34	3.34	3.34	3.85
	5700	1.64	2.13	2.13	1.68	2.13	2.13	2.13	2.47	2.01	3.00	3.00	2.31	3.00	3.00	3.00	3.28
	6000	1.45	1.92	1.92	1.43	1.90	1.92	1.92	2.13	1.78	2.71	2.71	1.95	2.71	2.71	2.71	2.82
SECTIONS BELOW EXCEED THE NORMAL DELIVERY LENGTH OF 12000 mm																	
	6300	1.29	1.74	1.74	1.22	1.68	1.74	1.74	1.86	1.58	2.45	2.45	1.67	2.39	2.45	2.45	2.45
	6600	1.16	1.59	1.59	1.05	1.50	1.59	1.59	1.63	1.41	2.24	2.24	1.43	2.11	2.24	2.24	2.14
	6900	1.04	1.45	1.45	0.91	1.34	1.45	1.45	1.44	1.27	2.05	2.05	1.24	1.88	2.05	2.05	1.88
	7200	0.93	1.33	1.33	0.80	1.02	1.33	1.33	1.27	1.15	1.88	1.88	1.08	1.68	1.88	1.88	1.67
	7500	0.85	1.23	1.23	0.70	1.07	1.23	1.23	1.14	1.04	1.73	1.73	0.94	1.5	1.73	1.73	1.48
	7800	0.77	1.14	1.14	0.62	0.97	1.14	1.14	1.02	0.94	1.60	1.6	0.83	1.35	1.60	1.60	1.31
	8100	0.70	1.05	1.05	0.54	0.87	1.05	1.05	0.91	0.86	1.48	1.48	0.74	1.22	1.48	1.48	1.17
	8400	0.64	0.98	0.98	0.48	0.78	0.96	0.98	0.82	0.79	1.36	1.38	0.66	1.09	1.37	1.38	1.05
	8700	0.59	0.90	0.91	0.43	0.70	0.88	0.91	0.74	0.72	1.25	1.29	0.59	0.97	1.25	1.29	0.95
	9000	0.54	0.84	0.85	0.42	0.62	0.81	0.85	0.67	0.66	1.16	1.20	0.53	0.87	1.15	1.20	0.86

Bold capacities require grade 8.8 purlin bolts. Values above horizontal line in body of table are governed by the strength of the grade 8.8 bolt. IN = Inward load capacity. OUT = Outward load capacity L/150 = load for deflection span/150. See also: Design notes for capacity tables.

Limit state capacity tables

Double continuous spans

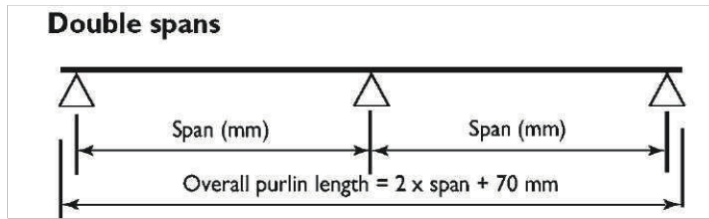

Double span: C/Z 20015 (kN/m)

Double span: C/Z 20019(kN/m)

Double span: C/Z 20024 (kN/m)

Span (mm)	Bridging >	C/Z 20015 (kN/m)					Load for deflection span/150	C/Z 20019(kN/m)					Load for deflection span/150	C/Z 20024 (kN/m)					Load for deflection span/150
		IN		OUT				IN		OUT				IN		OUT			
		0	1,2,3	0	1	2,3		0	1,2,3	0	1	2,3		0	1,2,3	0	1	2,3	
3000		6.10	6.10	6.10	6.10	6.10	25.47	10.69	10.69	10.69	10.7	10.7	36.3	13.82	13.82	13.82	13.82	13.82	47.93
3300		5.30	5.30	5.30	5.30	5.30	19.14	8.88	9.16	9.16	9.16	9.16	27.27	11.73	12.57	12.57	12.57	12.57	36.01
3600		4.64	4.64	4.64	4.64	4.64	14.74	7.24	7.81	7.81	7.81	7.81	21.00	9.48	11.36	11.36	11.36	11.36	27.73
3900		4.10	4.10	4.10	4.10	4.10	11.59	5.96	6.66	6.66	6.66	6.66	16.52	7.76	9.68	9.68	9.68	9.68	21.81
4200		3.64	3.64	3.64	3.64	3.64	9.28	4.96	5.74	5.74	5.74	5.74	13.23	6.42	8.34	8.34	8.34	8.34	17.47
4500		3.23	3.25	3.25	3.25	3.25	7.55	4.19	5.00	5.00	5.00	5.00	10.75	5.39	7.27	7.27	7.27	7.27	14.2
4800		2.79	2.88	2.88	2.88	2.88	6.22	3.47	4.39	4.39	4.39	4.39	8.86	4.59	6.39	6.30	6.39	6.39	11.70
5100		2.43	2.56	2.56	2.56	2.56	5.19	3.01	3.89	3.89	3.89	3.89	7.39	3.96	5.66	5.42	5.66	5.66	9.76
5400		2.14	2.28	2.28	2.28	2.28	4.37	2.63	3.47	3.46	3.47	3.47	6.22	3.44	5.05	4.70	5.05	5.05	8.22
5700		1.88	2.05	2.05	2.05	2.05	3.71	2.32	3.12	2.99	3.12	3.12	5.29	3.02	4.53	4.09	4.53	4.53	6.99
6000		1.66	1.85	1.80	1.85	1.85	3.18	2.06	2.81	2.59	2.81	2.81	4.54	2.67	4.09	3.58	4.09	4.09	5.99
SECTIONS BELOW EXCEED THE NORMAL DELIVERY LENGTH OF 12000 mm																			
6300		1.45	1.67	1.57	1.67	1.67	2.75	1.84	2.55	2.23	2.55	2.55	3.92	2.38	3.71	3.12	3.71	3.71	5.18
6600		1.32	1.53	1.35	1.53	1.53	2.39	1.65	2.32	1.86	2.32	2.32	3.41	2.13	3.38	2.72	3.38	3.38	4.50
6900		1.19	1.40	1.17	1.40	1.40	2.09	1.49	2.13	1.63	2.13	2.13	2.98	1.91	3.09	2.35	3.09	3.09	3.94
7200		1.07	1.28	1.02	1.28	1.28	1.84	1.35	1.95	1.43	1.95	1.95	2.63	1.72	2.84	2.05	2.83	2.84	3.47
7500		0.97	1.18	0.89	1.18	1.18	1.63	1.23	1.80	1.26	1.80	1.80	2.32	1.55	2.62	1.80	2.56	2.62	3.08
7800		0.89	1.09	0.79	1.09	1.09	1.45	1.12	1.66	1.12	1.66	1.66	2.08	1.41	2.42	1.59	2.32	2.42	2.76
8100		0.81	1.01	0.69	1.01	1.01	1.30	1.02	1.54	1.00	1.54	1.54	1.86	1.29	2.24	1.42	2.11	2.24	2.48
8400		0.74	0.94	0.62	0.94	0.94	1.18	0.94	1.44	0.90	1.40	1.44	1.68	1.18	2.09	1.25	1.92	2.09	2.24
8700		0.68	0.88	0.55	0.87	0.88	1.07	0.87	1.34	0.81	1.27	1.34	1.52	1.08	1.95	1.11	1.75	1.95	2.03
9000		0.62	0.82	0.47	0.79	0.82	0.98	0.80	1.25	0.72	1.15	1.25	1.37	0.99	1.80	0.99	1.60	1.82	1.84

Double span: C/Z 25019 (kN/m)

Double span: C/Z 25024 (kN/m)

Span (mm)	Bridging >	C/Z 25019 (kN/m)					Load for deflection span/150	C/Z 25024 (kN/m)					Load for deflection span/150
		IN		OUT				IN		OUT			
		0	1,2,3	0	1	2,3		0	1,2,3	0	1	2,3	
4500		5.27	5.83	5.83	5.83	5.83	17.47	6.82	9.22	9.22	9.22	9.22	24.09
4800		4.51	5.26	5.26	5.26	5.26	14.39	5.8	8.91	8.19	8.19	8.19	19.85
5100		3.90	4.77	4.77	4.77	4.77	12.00	4.99	7.25	7.25	7.25	7.25	16.55
5400		3.41	4.35	4.35	4.35	4.35	10.11	4.34	6.47	6.27	6.47	6.47	13.94
5700		3.00	3.96	3.96	3.96	3.96	8.59	3.81	5.81	5.45	5.81	5.81	11.85
6000		2.66	3.57	3.44	3.57	3.57	7.37	3.36	5.24	4.74	5.24	5.24	10.16
SECTIONS BELOW EXCEED THE NORMAL DELIVERY LENGTH OF 12000 mm													
6300		2.37	3.24	2.94	3.24	3.24	6.37	2.97	4.75	4.10	4.75	4.75	8.78
6600		2.12	2.95	2.46	2.95	2.95	5.54	2.65	4.33	3.53	4.33	4.33	7.64
6900		1.91	2.70	2.15	2.70	2.70	4.85	2.37	3.96	3.05	3.96	3.96	6.68
7200		1.73	2.48	1.88	2.48	2.48	4.26	2.13	3.64	2.65	3.64	3.64	5.88
7500		1.57	2.28	1.66	2.28	2.28	3.77	1.93	3.35	2.32	3.35	3.35	5.20
7800		1.43	2.11	1.47	2.11	2.11	3.35	1.75	3.10	2.05	3.10	3.10	4.63
8100		1.31	1.96	1.31	1.96	1.96	3.00	1.59	2.88	1.81	2.82	2.88	4.13
8400		1.20	1.82	1.17	1.82	1.82	2.69	1.46	2.67	1.59	2.56	2.67	3.70
8700		1.11	1.70	1.04	1.69	1.70	2.42	1.34	2.49	1.41	2.33	2.49	3.33
9000		1.02	1.59	0.93	1.53	1.59	2.18	1.23	2.33	1.25	2.13	2.33	3.01

Bold capacities require grade 8.8 purlin bolts. Values above horizontal line in body of table are governed by the strength of the grade 8.8 bolt. IN = Inward load capacity. OUT = Outward load capacity L/150 = load for deflection span/150. See also: Design notes for capacity tables.

Limit state capacity tables

Double lapped spans

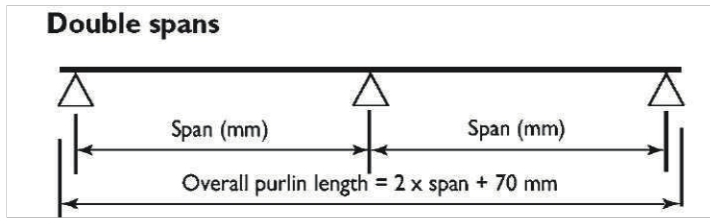

Double lapped Span: C/Z 30024 (kN/m)

Double lapped Span: C/Z 30030(kN/m)

Bridging >	IN		OUT		Load for deflection span/150	IN		OUT		Load for deflection span/150
	0	1,2,3	0	1,2,3		0	1,2,3	0	1,2,3	
span 6000	4.86	6.83	6.83	6.83	16.87	5.91	10.26	10.26	10.26	22.55
SECTIONS BELOW EXCEED THE NORMAL DELIVERY LENGTH OF 12000MM										
(mm)6300	4.31	6.31	6.31	6.31	14.57	5.17	9.31	9.26	9.31	19.44
6600	3.83	5.84	5.84	5.84	12.67	4.56	8.48	8.24	8.48	16.91
6900	3.42	5.41	5.41	5.41	11.09	4.05	7.76	7.37	7.76	14.79
7200	3.08	5.00	4.84	5.00	9.76	3.62	7.13	6.61	7.13	13.02
7500	2.78	4.61	4.32	4.61	8.64	3.25	6.57	5.95	6.57	11.52
7800	2.53	4.26	3.82	4.26	7.68	2.93	6.07	5.34	6.07	10.24
8100	2.30	3.95	3.38	3.95	6.85	2.66	5.63	4.76	5.63	9.15
8400	2.10	3.67	3.01	3.67	6.15	2.42	5.24	4.25	5.24	8.20
8700	1.92	3.42	2.65	3.42	5.53	2.21	4.88	3.80	4.88	7.38
9000	1.76	3.20	2.40	3.20	5.00	2.03	4.56	3.39	4.56	6.67
9300	1.62	3.00	2.17	3.00	4.53	1.87	4.27	3.03	4.27	6.04
9600	1.50	2.81	1.98	2.81	4.12	1.72	4.01	2.71	4.01	5.49

Bold capacities require grade 8.8 purlin bolts. Values above horizontal line in body of table are governed by the strength of the grade 8.8 bolt. IN = Inward load capacity. OUT = Outward load capacity L/150 = load for deflection span/150. See also: Design notes for capacity tables.

Limit state capacity tables

Double lapped spans

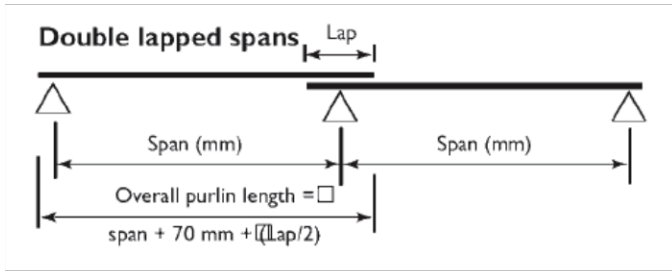

Double lapped span: C/Z 10019(kN/m)

Bridging >		IN			OUT			Load for deflection span/150	
		0	1	2,3	0	1 2	3		
Span (mm)	2100	15.08	15.08	15.08	15.08	15.08	15.08	15.08	21.19
	2400	11.70	11.70	11.70	11.70	11.70	11.70	11.70	13.97
	2700	6.57	8.63	8.63	8.49	8.63	8.63	8.63	9.67
	3000	5.02	6.59	6.59	6.24	6.59	6.59	6.59	6.96
	3300	3.96	5.20	5.20	4.70	5.20	5.20	5.20	5.18
	3600	3.19	4.21	4.21	3.63	4.21	4.21	4.21	3.95
	3900	2.62	3.48	3.48	2.86	3.48	3.48	3.48	3.08
	4200	2.19	2.92	2.92	2.27	2.92	2.92	2.92	2.45
	4500	1.85	2.49	2.49	1.82	2.48	2.49	2.49	1.98
	4800	1.58	2.15	2.15	1.48	2.09	2.15	2.15	1.63
	5100	1.36	1.87	1.87	1.22	1.77	1.87	1.87	1.36
	5400	1.19	1.65	1.65	1.01	1.50	1.65	1.65	1.14
	5700	1.04	1.46	1.46	0.84	1.29	1.46	1.46	0.97
	6000	0.92	1.30	1.30	0.71	1.11	1.30	1.30	0.83
	6300	0.84	1.26	1.30	0.63	1.03	1.26	1.30	0.74
	6600	0.75	1.12	1.17	0.54	0.88	1.11	1.17	0.64
6900	0.67	1.00	1.05	0.47	0.76	0.97	1.05	0.56	
7200	0.60	0.90	0.96	0.41	0.66	0.86	0.96	0.5	
7500	0.54	0.81	0.87		0.58	0.76	0.87	0.44	
7800	0.49	0.73	0.80		0.51	0.68	0.78	0.39	

Bold capacities require grade 8.8 purlin bolts. Values above horizontal line in body of table are governed by the strength of the grade 8.8 bolt. IN = Inward load capacity. OUT = Outward load capacity L/150 = load for deflection span/150. See also: Design notes for capacity tables.

Limit state capacity tables

Double lapped spans

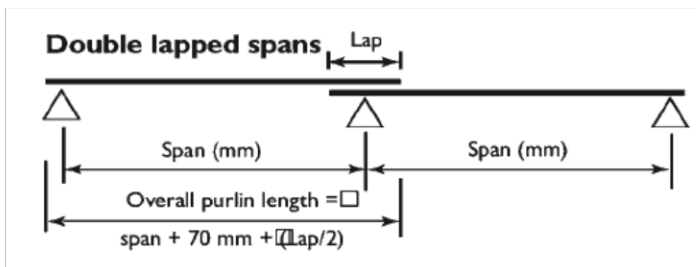

Double Lapped Span: C/Z 15015 (kN/m)

Span (mm)	Bridging>	IN			OUT				load for deflection span/150
		0	1	2,3	0	1	2	3	
11.37	14.23	14.23	14.23	14.23	14.23	14.23	14.23	14.23	31.72
11.37	11.37	11.37	11.37	11.37	11.37	11.37	11.37	11.37	22.02
9.30	9.30	9.30	9.30	9.30	9.30	9.30	9.30	9.30	15.86
7.76	7.76	7.76	7.76	7.76	7.76	7.76	7.76	7.76	11.79
6.53	6.53	6.53	6.53	6.53	6.53	6.53	6.53	6.53	8.99
3.79	5.36	5.36	5.36	5.17	5.36	5.36	5.36	5.36	7.00
3.13	4.42	4.42	4.42	4.10	4.42	4.42	4.42	4.42	5.55
2.63	3.70	3.70	3.70	3.28	3.70	3.70	3.70	3.70	4.48
2.23	3.15	3.15	3.15	2.63	3.15	3.15	3.15	3.15	3.66
1.92	2.72	2.72	2.72	2.08	2.72	2.72	2.72	2.72	3.03
1.67	2.37	2.37	2.37	1.73	2.37	2.37	2.37	2.37	2.54
1.46	2.08	2.08	2.08	1.45	2.08	2.08	2.08	2.08	2.15
1.28	1.84	1.84	1.84	1.23	1.84	1.84	1.84	1.84	1.83
1.14	1.64	1.64	1.64	1.05	1.64	1.64	1.64	1.64	1.57
1.02	1.48	1.48	1.48	0.91	1.42	1.48	1.48	1.48	1.36
0.91	1.33	1.33	1.33	0.79	0.25	1.33	1.33	1.33	1.19
0.82	1.21	1.21	1.21	0.68	0.10	1.21	1.21	1.21	1.05
0.74	1.10	1.10	1.10	0.59	0.96	1.10	1.10	1.10	0.93
0.67	1.01	1.01	1.01	0.52	0.84	1.01	1.01	1.01	0.83
0.61	0.93	0.93	0.93	0.45	0.72	0.93	0.93	0.93	0.74
0.56	0.85	0.85	0.85	0.40	0.64	0.85	0.85	0.85	0.66
0.51	0.79	0.79	0.79		0.57	0.79	0.79	0.79	0.60
0.47	0.73	0.73	0.73		0.51	0.73	0.73	0.73	0.54
0.45	0.71	0.73	0.73		0.48	0.73	0.73	0.73	0.50
0.41	0.65	0.68	0.68		0.44	0.68	0.68	0.68	0.46
0.60	0.63	0.63	0.63			0.63	0.63	0.63	0.42

Bold capacities require grade 8.8 purlin bolts. Values above horizontal line in body of table are governed by the strength of the grade 8.8 bolt. IN = Inward load capacity. OUT = Outward load capacity L/150 = load for deflection span/150 See also: Design notes for capacity tables.

Limit state capacity tables

Double lapped spans

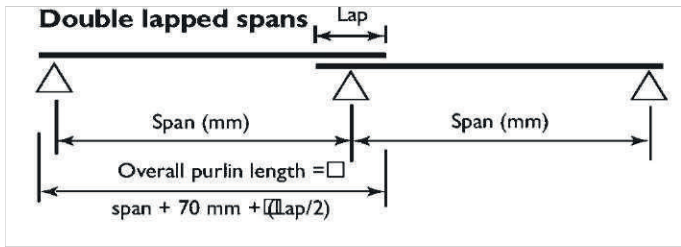

Double Lapped Span: C/Z 15019 (kN/m)

Double Lapped Span: C/Z 15024 (kN/m)

Bridging >	Load for								deflection span/l 50	Load for								deflection span/ISO
	IN			OUT				0		IN			OUT					
0	1	2,3	0	1	2	3	0		1	2,3	0	1	2	3				
Span 2400	20.06	20.06	20.06	20.06	20.06	20.06	20.06	41.39	21.18	21.18	21.18	21.18	21.18	21.18	21.18	55.20		
(mm) 2700	15.80	16.03	16.03	16.03	16.03	16.03	16.03	28.73	18.88	18.88	18.88	18.88	18.88	18.88	18.88	38.30		
3000	12.63	13.12	13.12	13.12	13.12	13.12	13.12	20.70	17.03	17.03	17.03	17.03	17.03	17.03	17.03	27.60		
3300	10.31	10.94	10.94	10.94	10.94	10.94	10.94	15.38	13.92	15.42	15.42	15.42	15.42	15.42	15.42	20.51		
3600	8.58	9.27	9.27	9.27	9.27	9.27	9.27	11.72	11.49	13.06	13.06	13.06	13.06	13.06	13.06	15.64		
3900	4.75	7.55	7.55	6.84	7.55	7.55	7.55	9.13	5.66	10.64	10.64	9.48	10.64	10.64	10.64	12.18		
4200	3.93	6.22	6.22	5.46	6.22	6.22	6.22	7.25	4.67	8.77	8.77	7.53	8.77	8.77	8.77	9.66		
4500	3.30	5.22	5.22	4.42	5.22	5.22	5.22	5.84	3.92	7.36	7.36	6.08	7.36	7.36	7.36	7.79		
4800	2.80	4.44	4.44	3.59	4.44	4.44	4.44	4.78	3.33	6.26	6.26	4.93	6.26	6.26	6.26	6.37		
5100	2.41	3.83	3.83	2.95	3.83	3.83	3.83	3.96	2.86	5.40	5.40	3.99	5.40	5.40	5.40	5.28		
5400	2.09	3.34	3.34	2.42	3.32	3.34	3.34	3.31	2.48	4.69	4.70	3.27	4.70	4.70	4.70	4.42		
5700	1.83	2.93	2.93	2.01	2.85	2.93	2.93	2.8	2.17	4.08	4.13	2.71	4.05	4.13	4.13	3.73		
6000	1.61	2.58	2.60	1.69	2.47	2.60	2.60	2.39	1.92	3.57	3.66	2.27	3.49	3.66	3.66	3.18		
6300	1.43	2.29	2.32	1.44	2.16	2.32	2.32	2.05	1.70	3.16	3.26	1.91	3.04	3.26	3.26	2.74		
6600	1.28	2.04	2.08	1.23	1.89	2.08	2.08	1.78	1.52	2.81	2.93	1.63	2.65	2.93	2.93	2.37		
6900	1.14	1.83	1.88	1.05	1.67	1.88	1.88	1.56	1.36	2.51	2.65	1.40	2.33	2.65	2.65	2.07		
7200	1.03	1.64	1.70	0.91	1.48	1.70	1.70	1.38	1.23	2.26	2.40	1.21	2.06	2.40	2.40	1.82		
7500	0.93	1.49	1.55	0.79	1.30	1.55	1.55	1.22	1.11	2.04	2.19	1.05	1.83	2.19	2.19	1.61		
7800	0.85	1.35	1.42	0.69	1.16	1.39	1.42	1.09	1.01	1.85	2.00	0.92	1.62	1.98	2.00	1.43		
8100	0.77	1.23	1.30	0.60	1.03	1.26	1.31	0.98	0.92	1.68	1.84	0.80	1.44	1.79	1.84	1.28		
8400	0.70	1.13	1.20	0.53	0.92	1.14	1.20	0.88	0.84	1.54	1.70	0.72	1.27	1.61	1.70	1.15		
8700	0.64	1.03	1.10	0.47	0.81	1.04	1.11	0.80	0.77	1.41	1.57	0.64	1.12	1.46	1.57	1.04		
9000	0.59	0.95	1.03	0.42	0.72	0.94	1.03	0.72	0.71	1.29	1.46	0.57	1.00	1.33	1.46	0.94		
9300	0.55	0.92	1.03		0.67	0.9	1.02	0.67	0.66	1.24	1.45	0.53	0.91	1.27	1.45	0.87		
9600	0.51	0.85	0.96		0.60	0.83	0.94	0.61	0.61	1.14	1.35	0.48	0.82	1.16	1.34	0.79		
9900	0.47	0.78	0.89		0.54	0.76	0.86	0.56	0.57	1.06	1.26	0.43	0.73	1.06	1.23	0.72		
10200	0.43	0.73	0.83		0.49	0.69	0.80	0.51	0.53	0.98	1.17		0.66	0.97	1.13	0.65		
10500	0.40	0.67	0.77		0.44	0.63	0.73	0.46	0.49	0.91	1.08		0.60	0.88	1.04	0.60		

Bold capacities require grade 8.8 purlin bolts. Values above horizontal line in body of table are governed by the strength of the grade 8.8 bolt. IN = Inward load capacity. OUT = Outward load capacity L/150 = load for deflection span/150. See also: Design notes for capacity tables.

Limit state capacity tables

Double lapped spans

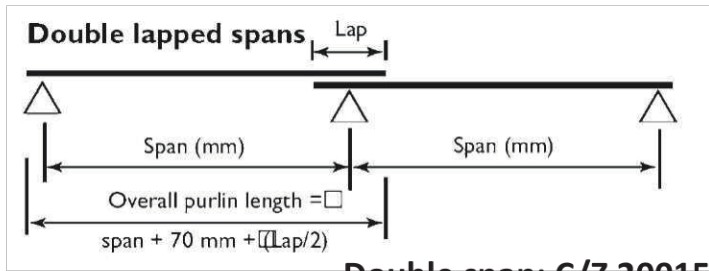

Double span: C/Z 20015 (kN/m)

Bridging >	span (mm)	IN		OUT				Loadfor deflection
		0	1,2,3	0	1	2	3	span/150
	3000	9.07	9.07	9.07	9.07	9.07	9.07	31.37
	3300	7.71	7.71	7.71	7.71	7.71	7.71	23.30
	3600	6.63	6.63	6.63	6.63	6.63	6.63	17.76
	3900	5.54	5.75	5.75	5.75	5.75	5.75	13.84
	4200	4.56	5.02	5.02	5.02	5.02	5.02	10.98
	4500	3.81	4.42	4.42	4.42	4.42	4.42	8.86
	4800	3.23	3.92	3.92	3.92	3.92	3.92	7.24
	5100	2.78	3.49	3.49	3.49	3.49	3.49	6.00
	5400	2.41	3.13	3.10	3.13	3.13	3.13	5.02
	5700	2.10	2.82	2.62	2.82	2.82	2.82	4.24
	6000	1.85	2.50	2.20	2.50	2.50	2.50	3.62
	6300	1.64	2.23	1.86	2.23	2.23	2.23	3.11
	6600	1.46	2.00	1.59	2.00	2.00	2.00	2.69
	6900	1.31	1.81	1.37	1.81	1.81	1.81	2.35
	7200	1.18	1.64	1.18	1.64	1.64	1.64	2.06
	7500	1.07	1.49	1.03	1.49	1.49	1.49	1.81
	7800	0.97	1.37	0.90	1.37	1.37	1.37	1.61
	8100	0.88	1.26	0.79	1.26	1.26	1.26	1.28
	8400	0.81	1.16	0.67	1.15	1.16	1.16	1.28
	8700	0.74	1.07	0.60	1.04	1.07	1.07	1.15
	9000	0.68	0.99	0.54	0.94	0.99	0.99	1.03
	9300	0.64	0.99	0.50	0.87	0.99	0.99	0.96
	9600	0.59	0.92	0.45	0.78	0.92	0.92	0.87
	9900	0.54	0.86	0.41	0.70	0.92	0.92	0.87
	10200	0.50	0.80		0.63	0.80	0.80	0.73
	10500	0.47	0.75		0.57	0.75	0.75	0.68
	10800	0.43	0.71		0.52	0.71	0.71	0.63
	11100		0.66		0.47	0.66	0.66	0.58
	11400		0.63		0.43	0.61	0.63	0.54
SECTION BELOW EXCEED THE NORMAL DELIVERY LENGTH OF 12000 MM								
	11700		0.59			0.56	0.59	0.50
	12000		0.56			0.52	0.56	0.47

Bold capacities require grade 8.8 purlin bolts. Values above horizontal line in body of table are governed by the strength of the grade 8.8 bolt. IN = Inward load capacity. OUT = Outward load capacity L/150 = load for deflection span/150. See also: Design notes for capacity tables.

Limit state capacity tables

Double lapped spans

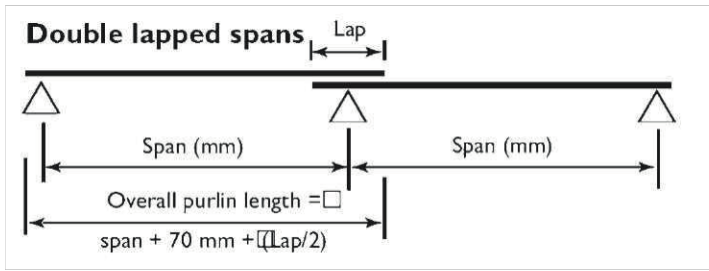

Double Lapped Span: C/Z 20019 (kN/m)

Double Lapped Span: C/Z 20024 (kN/m)

Bridging >	IN			OUT				Load for deflection span/150	IN			OUT				Load for deflection span/150
	0	1	2,3	0	1	2	3		0	1	2,3	0	1	2	3	
Span 3000	17.00	17.00	17.00	17.00	17.00	17.00	17.00	44.69	17.03	17.03	17.03	17.03	17.03	17.03	17.03	59.02
(mm) 3300	14.16	14.16	14.16	14.16	14.16	14.16	14.16	33.21	15.51	15.51	15.51	15.51	15.51	15.51	15.51	43.85
3600	11.94	11.94	11.94	11.94	11.94	11.94	11.94	25.31	14.25	14.25	14.25	14.25	14.25	14.25	14.25	33.42
3900	7.09	10.18	10.18	10.18	10.18	10.18	10.18	19.72	8.88	13.18	13.18	13.18	13.18	13.18	13.18	26.04
4200	5.82	8.77	8.77	8.77	8.77	8.77	8.77	15.65	7.24	12.25	1125	1225	12.25	12.25	12.25	20.66
4500	4.86	7.61	7.61	7.61	7.61	7.61	7.61	12.62	6.01	11.12	11.12	10.51	11.12	11.12	11.12	16.66
4800	4.12	6.51	6.51	6.39	6.51	6.51	6.51	10.32	5.06	9.46	9.46	8.70	9.46	9.46	9.46	13.63
5100	3.53	5.61	5.61	5.31	5.61	5.61	5.61	8.54	4.32	8.15	8.15	7.28	8.15	8.15	8.15	11.28
5400	3.06	4.88	4.88	4.45	4.88	4.88	4.88	7.15	3.73	7.10	7.10	6.16	7.10	7.10	7.10	9.44
5700	2.67	4.29	4.29	3.70	4.29	4.29	4.29	6.05	3.25	6.24	6.24	5.19	6.24	6.24	6.24	7.98
6000	2.36	3.80	3.80	3.02	3.80	3.80	3.80	5.16	2.85	5.53	5.53	4.38	5.53	5.53	5.53	6.81
6300	2.09	3.39	3.39	2.58	3.39	3.39	3.39	4.43	2.52	4.90	4.93	3.71	4.93	4.93	4.93	5.85
6600	1.87	3.05	3.05	2.22	3.05	3.05	3.05	3.84	2.25	4.36	4.43	3.17	4.43	4.43	4.43	5.06
6900	1.67	2.75	2.75	1.93	2.75	2.75	2.75	3.34	2.01	3.90	4.00	2.73	3.96	4.00	4.00	4.41
7200	1.51	2.50	2.50	1.68	2.50	2.50	2.50	2.93	1.81	3.51	3.63	2.37	3.53	3.63	3.63	3.87
7500	1.37	2.28	2.28	1.48	2.28	2.28	2.28	2.58	1.64	3.17	3.31	2.07	3.15	3.31	3.31	3.41
7800	1.24	2.08	2.08	1.30	2.07	2.08	2.08	2.29	1.49	2.88	3.03	1.80	2.83	3.03	3.03	3.02
8100	1.13	1.91	1.91	1.16	1.86	1.91	1.91	2.04	1.35	2.63	2.78	1.57	2.55	2.78	2.78	2.69
8400	1.04	1.76	1.76	1.02	1.67	1.76	1.76	1.82	1.24	2.40	2.57	1.39	2.31	2.57	2.57	2.40
8700	0.95	1.63	1.63	0.90	1.50	1.63	1.63	1.63	1.14	2.21	2.37	1.22	2.09	2.37	2.37	2.16
9000	0.87	1.51	1.51	0.80	1.35	1.51	1.51	1.48	1.05	2.03	2.20	1.09	1.90	2.20	2.20	1.96
9300	0.82	1.48	1.51	0.74	1.20	1.51	1.51	1.37	0.97	1.96	2.19	1.00	1.79	2.17	2.19	1.82
9600	0.75	1.37	1.40	0.67	1.09	1.40	1.40	1.25	0.90	1.81	2.04	0.89	1.60	1.99	2.04	1.66
9900	0.70	1.26	1.31	0.60	0.99	1.31	1.31	1.14	0.83	1.68	1.90	0.80	1.44	1.83	1.90	1.52
10200	0.65	1.17	1.22	0.54	0.90	1.22	1.22	1.04	0.78	1.56	1.78	0.72	1.30	1.68	1.78	1.39
10500	0.60	1.09	1.15	0.49	0.82	1.13	1.15	0.96	0.72	1.45	1.67	0.65	1.18	1.56	1.67	1.28
10800	0.56	1.01	1.08	0.44	0.75	1.04	1.08	0.88	0.67	1.35	1.57	0.59	1.07	1.44	1.57	1.18
1100	0.52	0.94	1.01	0.40	0.68	0.96	1.01	0.81	0.63	1.26	1.47	0.54	0.98	1.33	1.47	1.09
11400	0.49	0.88	0.95		0.63	0.89	0.95	0.75	0.59	1.17	1.39	0.49	0.89	1.24	1.39	1.01
SECTION BELOW EXCEED THE NORMAL DEIVERY LENGTH OF 12000 MM																
11700	0.46	0.82	0.90		0.58	0.82	0.90	0.69	0.55	1.09	1.31	0.45	0.82	1.15	1.30	0.94
12000	0.43	0.77	0.85		0.53	0.75	0.85	0.64	0.52	1.02	1.23	0.41	0.75	1.07	1.21	0.87

Bold capacities require grade 8.8 purlin bolts. Values above horizontal line in body of table are governed by the strength of the grade 8.8 bolt. IN = Inward load capacity. OUT = Outward load capacity L/150 = load for deflection span/150. See also: Design notes for capacity tables.

Limit state capacity tables

Double lapped spans

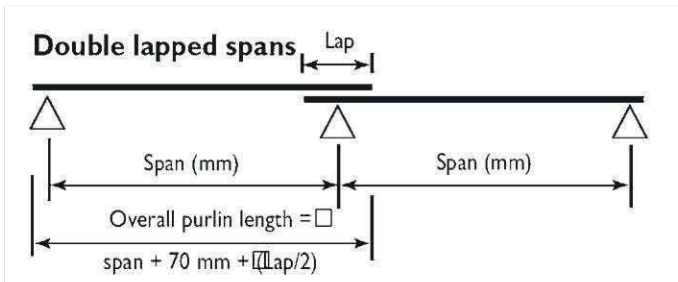

Double Lapped Span: C/Z 25019 (kN/m)

Double Lapped Span: C/Z 25024 (kN/m)

Bridging >	IN			OUT				Load for deflection span/150	IN			OUT				Load for deflection span/150	
	0	1	2,3	0	1	2	3		0	1	2,3	0	1	2	3		
Span 3000	15.13	15.13	15.13	15.13	15.13	15.13	15.13	72.59	17.03	17.03	17.03	17.03	17.03	17.03	17.03	17.03	100.2
(mm) 3300	13.00	13.00	13.00	13.00	13.00	13.00	13.00	53.93	15.51	15.51	15.51	15.51	15.51	15.51	15.51	15.51	74.38
3600	11.28	11.28	11.28	11.28	11.28	11.28	11.28	41.11	<u>14.25</u>	14.25	14.25	14.25	14.25	14.25	14.25	14.25	56.70
3900	9.11	9.88	9.88	9.88	9.88	9.88	9.88	32.02	11.10	13.18	13.18	13.18	13.18	13.18	13.18	13.18	44.17
4200	7.47	8.72	8.72	8.72	8.72	8.72	8.72	25.41	9.04	12.25	12.25	12.25	12.25	12.25	12.25	12.25	35.05
4500	6.23	7.74	7.74	7.74	7.74	7.74	7.74	20.49	7.49	11.45	11.45	11.45	11.45	11.45	11.45	11.45	28.26
4800	5.27	6.91	6.91	6.91	6.91	6.91	6.91	16.76	6.30	10.75	10.75	<u>10.75</u>	10.75	10.75	10.75	10.75	23.11
5100	4.51	6.20	6.20	6.20	6.20	6.20	6.20	13.88	5.37	10.13	10.13	9.70	10.13	10.13	10.13	10.13	19.14
5400	3.91	5.59	5.59	5.59	5.59	5.59	5.59	1.61	4.63	9.06	9.06	8.12	9.06	9.06	9.06	9.06	16.02
5700	3.41	5.07	5.07	4.90	5.07	5.07	5.07	9.82	4.03	8.00	8.00	6.82	8.00	8.00	8.00	8.00	13.54
6000	3.00	4.61	4.61	4.00	4.61	4.61	4.61	8.37	3.53	7.09	7.09	5.71	7.09	7.09	7.09	7.09	11.55
6300	2.66	4.02	4.20	3.41	4.20	4.20	4.20	7.20	3.12	6.32	6.32	4.82	6.32	6.32	6.32	6.32	9.93
6600	2.37	3.85	3.85	2.93	3.85	3.85	3.85	6.23	2.78	5.68	5.68	4.11	5.68	5.68	5.68	5.68	8.59
6900	2.12	3.49	3.49	2.53	3.49	3.49	3.49	5.43	2.49	5.13	5.13	3.53	5.13	5.13	5.13	5.13	7.49
7200	1.91	3.17	3.17	2.20	3.17	3.17	3.17	4.76	2.24	4.65	4.65	3.06	4.65	4.65	4.65	4.65	6.56
7500	1.72	2.89	2.89	1.93	2.89	2.89	2.89	4.19	2.02	4.22	4.24	2.65	4.22	4.24	4.24	4.24	5.78
7800	1.56	2.64	2.64	1.70	2.64	2.64	2.64	3.72	1.83	3.82	3.88	2.30	3.78	3.88	3.88	3.88	5.12
B100	1.42	2.43	2.43	1.50	2.43	2.43	2.43	3.31	1.67	3.48	3.57	2.01	3.40	3.57	3.57	3.57	4.56
B400	1.30	2.24	2.24	1.31	2.23	2.24	2.24	2.96	1.53	3.18	3.29	1.76	3.07	3.29	3.29	3.29	4.08
B700	1.19	2.07	2.07	1.16	2.00	2.07	2.07	2.65	1.40	2.92	3.04	1.56	2.77	3.04	3.04	3.04	3.66
9000	1.10	1.92	1.92	1.03	1.78	1.92	1.92	2.39	1.29	2.68	2.82	1.38	2.49	2.82	2.82	2.82	3.30
9300	1.02	1.92	1.92	0.95	1.60	1.92	1.92	2.22	1.20	2.58	2.81	1.26	2.33	2.81	2.81	2.81	3.05
9600	0.95	1.78	1.78	0.85	1.44	1.78	1.78	2.01	0.10	2.38	2.62	1.12	2.08	2.62	2.62	2.62	2.77
9900	0.88	1.66	1.66	0.76	1.30	1.66	1.66	1.83	1.02	2.19	2.44	1.01	1.87	2.44	2.44	2.44	2.52
10200	0.81	1.55	1.55	0.69	1.18	1.55	1.55	1.66	0.95	2.03	2.28	0.90	1.68	2.25	2.28	2.28	2.30
10500	0.76	1.44	1.46	0.62	1.07	1.46	1.46	1.52	0.88	1.88	2.14	0.81	1.52	2.08	2.14	2.14	2.10
10800	0.70	1.34	1.37	0.56	0.98	1.37	1.37	1.40	0.82	1.74	2.01	0.74	1.38	1.92	2.01	2.01	1.92
11100	0.66	1.24	1.29	0.50	0.89	1.29	1.29	1.28	0.77	1.62	1.89	0.67	1.26	1.77	1.89	1.89	1.78
11400	0.61	1.15	1.21	0.46	0.82	1.19	1.21	1.18	0.72	1.51	1.78	0.61	1.15	1.64	1.78	1.78	1.64
SECTION BELOW EXCEED THE NORMAL DEIVERY LENGTH OF 12000 MM																	
11700	0.57	1.07	1.14	0.41	0.75	1.09	1.14	1.10	0.67	1.14	1.68	0.55	1.05	1.52	1.68	1.68	1.52
12000	0.54	1.00	1.08	0.39	0.69	1.00	1.08	1.03	0.63	1.31	1.59	0.51	0.95	1.40	1.59	1.59	1.42

Bold capacities require grade 8.8 purlin bolts. Values above horizontal line in body of table are governed by the strength of the grade 8.8 bolt. IN = Inward load capacity. OUT = Outward load capacity L/150 = load for deflection span/150. See also: Design notes for capacity tables.

Limit state capacity tables

Double lapped spans

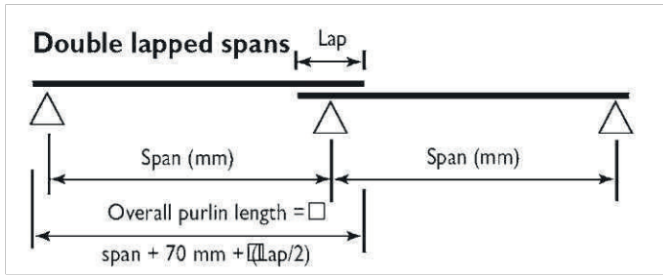

Double Lapped Span: C/Z 30024 (kN/m)

Double Lapped Span: C/Z 30024/30030 (kN/m)

Bridging > Span mm	INWARD			OUTWARD				L/150	INWARD				OUTWARD				L/150
	0	1	2	0	1	2	3		0	1	2	3	0	1	2	3	
6000	5.26	8.51	8.51	8.51	8.51	8.51	8.51	19.16	6.18	13.28	13.28	13.28	13.28	13.28	13.28	13.28	25.70
6300	4.61	7.80	7.80	7.80	7.80	7.80	7.80	16.47	5.40	12.05	12.05	12.05	11.73	12.05	12.05	12.05	21.97
6600	4.06	7.17	7.17	7.17	7.17	7.17	7.17	14.26	4.75	10.98	10.98	10.98	10.29	10.98	10.98	10.98	19.02
6900	3.61	6.61	6.61	6.59	6.61	6.61	6.61	12.42	4.21	10.04	10.04	10.04	9.08	10.04	10.04	10.04	16.58
7200	3.23	6.12	6.12	5.72	6.12	6.12	6.12	10.89	3.75	9.11	9.11	9.11	8.00	9.11	9.11	9.11	14.53
7500	2.90	5.67	5.67	4.99	5.67	5.67	5.67	9.60	3.37	8.30	8.30	8.30	7.01	8.30	8.30	8.30	12.81
7800	2.62	5.27	5.27	4.37	5.27	5.27	5.27	8.50	3.03	7.54	7.60	7.60	6.15	7.60	7.60	7.60	11.35
8100	2.38	4.90	4.90	3.80	4.90	4.90	4.90	7.57	2.75	6.86	6.98	6.98	5.44	6.98	6.98	6.98	10.10
8400	2.17	4.51	4.51	3.39	4.51	4.51	4.51	6.77	2.50	6.26	6.44	6.44	4.78	6.44	6.44	6.44	9.03
8700	1.98	4.18	4.18	3.04	4.18	4.18	4.18	6.07	2.29	5.74	5.95	5.95	4.22	5.95	5.95	5.95	8.10
9000	1.82	3.87	3.87	2.73	3.87	3.87	3.87	5.47	2.1	5.27	5.52	5.52	3.74	5.52	5.52	5.52	7.30
9300	1.69	3.86	3.86	2.58	3.86	3.86	3.86	5.07	1.94	5.10	5.51	5.51	3.43	5.45	5.51	5.51	6.76
9600	1.56	3.55	3.59	2.31	3.59	3.59	3.59	4.59	1.79	4.71	5.12	5.12	3.06	5.00	5.12	5.12	6.13
9900	1.44	3.28	3.35	2.08	3.35	3.35	3.35	4.18	1.66	4.35	4.78	4.78	2.73	4.59	4.78	4.78	5.57
10200	1.34	3.03	3.13	1.88	3.10	3.13	3.13	3.81	1.54	4.03	4.47	4.47	2.45	4.23	4.47	4.47	5.08
10500	1.24	2.81	2.93	1.70	2.85	2.93	2.93	3.48	1.43	3.75	0.18	0.18	2.21	3.91	0.18	0.18	4.65
10800	1.16	2.62	2.75	1.53	2.62	2.75	2.75	3.19	1.33	3.48	3.93	3.93	2.00	3.61	3.93	3.93	4.26
11100	1.08	2.44	2.59	1.39	2.41	2.59	2.59	2.93	1.25	3.23	3.69	3.69	1.81	3.35	3.69	3.69	3.91
11400	1.01	2.27	2.44	1.26	2.20	2.44	2.44	2.70	1.17	3.01	3.48	3.48	1.64	3.10	3.48	3.48	3.61

SECTION BELOW EXCEED THE NORMAL DEIVERY LENGTH OF 12000 MM

11700	0.95	2.12	2.30	1.15	2.02	2.30	2.30	2.49	1.09	2.80	3.29	3.29	1.50	2.86	3.29	3.29	3.33
12000	0.89	1.98	2.18	1.05	1.85	2.18	2.18	2.31	1.03	2.62	3.11	3.11	1.37	2.63	3.11	3.11	3.08
12300	0.85	1.91	2.30	1.00	1.78	2.30	2.30	2.22	0.98	2.55	3.27	3.27	1.31	2.57	3.25	3.27	2.96
12600	0.80	1.79	2.17	0.91	1.64	2.17	2.17	2.06	0.92	2.38	3.10	3.10	1.20	2.36	3.04	3.10	2.75
12900	0.75	1.68	2.06	0.84	1.52	2.06	2.06	1.91	0.87	2.22	2.93	2.93	1.10	2.17	2.85	2.93	2.55
13200	0.71	1.57	1.95	0.77	1.41	1.95	1.95	1.78	0.82	2.08	2.78	2.78	1.01	1.99	2.67	2.78	2.38
13500	0.67	1.45	1.85	0.71	1.31	1.83	1.85	1.66	0.78	1.95	2.64	2.64	0.93	1.84	2.51	2.64	2.23
13800	0.64	1.37	1.76	0.65	1.22	1.72	1.76	1.56	0.74	1.83	2.51	2.51	0.86	1.69	2.36	2.51	2.09
14100	0.60	1.30	1.68	0.6	1.14	1.61	1.68	1.47	0.70	1.72	2.39	2.39	0.80	1.57	2.22	2.39	1.97
14400	0.57	1.22	1.60	0.56	1.07	1.51	1.6	1.39	0.66	1.62	2.27	2.28	0.74	1.45	2.09	2.27	1.85
14700	0.54	1.16	1.52	0.52	1.00	1.41	1.52	1.32	0.63	1.53	2.15	2.17	0.69	1.34	1.97	2.15	1.75
15000	0.52	1.10	1.46	0.48	0.93	1.32	1.46	1.25	0.60	1.45	2.05	2.08	0.64	1.25	1.86	2.05	1.65
15300	0.49	1.04	1.39	0.45	0.87	1.23	1.39	1.18	0.57	1.37	1.95	1.98	0.60	1.16	1.75	1.95	1.56
15600	0.47	0.99	1.33	0.42	0.81	1.16	1.33	1.12	0.55	1.29	1.85	1.90	0.56	1.08	1.65	1.85	1.48
15900	0.45	0.94	1.28		0.76	1.08	1.28	1.05	0.52	1.23	1.76	1.82	0.52	1.01	1.55	1.76	1.40
16200	0.43	0.90	1.22		0.71	1.02	1.22	1.00	0.50	1.16	1.68	1.75	0.49	0.94	1.45	1.68	1.33
16500	0.41	0.85	1.18		0.66	0.95	1.18	0.94	0.48	1.10	1.60	1.68	0.46	0.88	1.37	1.60	1.26
16800		0.81	1.13		0.62	0.88	1.13	0.90	0.46	1.05	1.53	1.61	0.43	0.82	1.29	1.53	1.20
17100		0.78	1.09		0.58	0.83	1.08	0.85	0.44	1.00	1.46	1.55	0.41	0.77	1.21	1.46	1.14
17400		0.74	1.04		0.54	0.79	1.02	0.81	0.42	0.95	1.40	1.49		0.72	1.14	1.40	1.08
17700		0.71	1.00		0.51	0.75	0.97	0.77	0.40	0.91	1.34	1.43		0.68	1.07	1.34	1.03

Bold capacities require grade 8.8 purlin bolts. Values above horizontal line in body of table are governed by the strength of the grade 8.8 bolt. IN = Inward load capacity. OUT = Outward load capacity L/150 = load for deflection span/150. See also: Design notes for capacity tables.

Limit state capacity tables

Three continuous spans

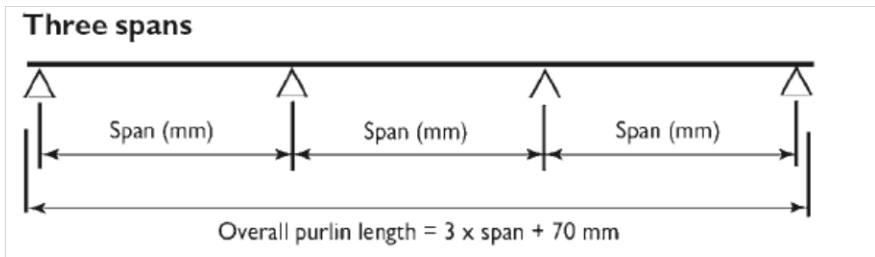

Three continuous span: C/Z 10019 (kN/m)

Bridging >	IN		OUT				Load for deflection span/150
	0	1,2,3	0	1	2	3	
span 2100	10.14	10.99	10.99	10.99	10.99	10.99	13.61
(mm) 2400	7.50	8.41	8.41	8.41	8.41	8.41	9.18
2700	5.75	6.65	6.45	6.65	6.65	6.65	6.47
3000	4.54	5.38	4.90	5.38	5.38	5.38	4.75
3300	3.66	4.45	3.78	4.45	4.45	4.45	3.59
3600	3.01	3.74	2.96	3.74	3.74	3.74	2.79
3900	2.50	3.19	2.30	3.17	3.19	3.19	2.20
SECTION BELOW EXCEED THE NORMAL DEIVERY LENGTH OF 12000 MM							
4200	2.09	2.75	1.83	2.65	2.75	2.75	1.76
4500	1.78	2.39	1.46	2.2	2.39	2.39	1.43
4800	1.52	2.10	1.18	1.85	2.10	2.10	1.18
1500	1.32	1.86	0.96	1.56	1.86	1.86	0.98
5400	1.15	1.66	0.80	1.32	1.66	1.66	0.83
5700	1.01	1.49	0.67	1.11	1.45	1.49	0.70
6000	0.88	1.35	0.57	0.95	1.27	1.35	0.60

Bold capacities require grade 8.8 purlin bolts. Values above horizontal line in body of table are governed by the strength of the grade 8.8 bolt. IN = Inward load capacity. OUT = Outward load capacity L/150 = load for deflection span/150. See also: Design notes for capacity tables.

Limit state capacity tables

Three continuous spans

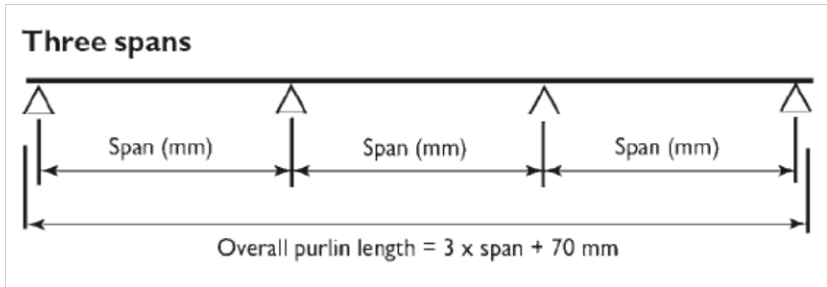

Three span: C/Z 15015 (kN/m)

Bridging >	IN		OUT			Load for deflection span/150
	0	1,2,3	0	1	3	
Span 2100	11.84	11.84	11.84	11.84	11.84	29.55
(mm) 2400	9.65	9.65	9.65	9.65	9.65	19.8
2700	7.99	7.99	7.99	7.99	7.99	13.9
3000	6.38	6.72	6.72	6.72	6.72	10.14
3300	5.13	5.63	5.63	5.63	5.63	7.62
3600	4.20	4.73	4.71	4.73	4.73	5.88
3900	3.47	4.03	3.80	4.03	4.03	4.67
4200	SECTION BELOW EXCEED THE NORMAL DEIVERY LENGTH OF 12000 MM					
	2.90	3.47	3.08	3.47	3.47	3.77
4500	2.46	3.03	2.47	3.03	3.03	3.09
4800	2.05	2.66	1.96	2.66	2.66	2.57
5100	1.78	2.36	1.63	2.36	2.36	2.15
5400	1.56	2.10	1.37	2.10	2.10	1.83
5700	1.37	1.89	1.16	1.83	1.89	1.57
6000	1.21	1.70	0.99	1.58	1.70	1.36
6300	1.08	1.54	0.84	1.38	1.54	1.18

Three span: Z/C 15019 (kN/m)

Three span: Z/C 15024 (kN/m)

Bridging >	IN		OUT			Load for deflection span/150	IN		OUT			Load for deflection span/150
	0	1,2,3	0	1	2,3		0	1,2,3	0	1	2,3	
Span 2100	17.77	17.77	17.77	17.77	17.77	38.56	22.44	22.44	22.44	22.44	22.44	51.42
(mm) 2400	13.50	14.45	14.45	14.45	14.45	25.83	18.03	19.64	19.64	19.64	19.64	34.45
2700	10.32	11.70	11.70	11.70	11.70	18.14	13.58	16.70	16.70	16.70	16.7	24.19
3000	3.09	9.60	9.60	9.60	9.60	13.23	10.38	13.53	13.53	13.53	13.53	17.64
3300	6.46	7.93	7.74	7.93	7.93	9.94	8.10	11.18	10.94	11.18	11.18	3.25
3600	5.26	6.67	6.22	6.67	6.67	7.70	6.50	9.39	8.71	9.39	9.39	10.25
3900	4.36	5.68	5.06	5.68	5.68	6.14	5.30	8.00	7.03	8.00	8.00	8.10
4200	SECTION BELOW EXCEED THE NORMAL DEIVERY LENGTH OF 12000 MM											
	3.64	4.90	4.16	4.90	4.90	4.98	4.42	6.90	5.75	6.90	6.90	6.54
4500	3.08	4.27	3.39	4.27	4.27	4.10	3.72	6.01	4.67	6.00	6.01	5.36
4800	2.64	3.75	2.76	3.75	3.75	3.42	3.18	5.28	3.75	5.28	5.28	4.44
5100	2.28	3.32	2.26	3.23	3.32	2.87	2.74	4.68	3.05	4.58	4.68	3.7C
5400	0.99	2.96	1.87	2.79	2.96	2.42	2.39	4.18	2.50	3.94	4.18	3.12
5700	0.74	2.66	1.58	2.43	2.66	2.07	2.09	3.75	2.09	3.40	3.75	2.65
6000	1.54	2.40	1.32	2.13	2.40	1.78	1.85	3.38	1.76	2.97	3.38	2.27
6300	1.37	2.18	1.11	1.87	2.18	1.54	1.64	3.07	1.49	2.60	3.07	1.96

Bold capacities require grade 8.8 purlin bolts. Values above horizontal line in body of table are governed by the strength of the grade 8.8 bolt. IN = Inward load capacity. OUT = Outward load capacity L/150 = load for deflection span/150. See also: Design notes for capacity tables.

Limit state capacity tables

Three continuous spans

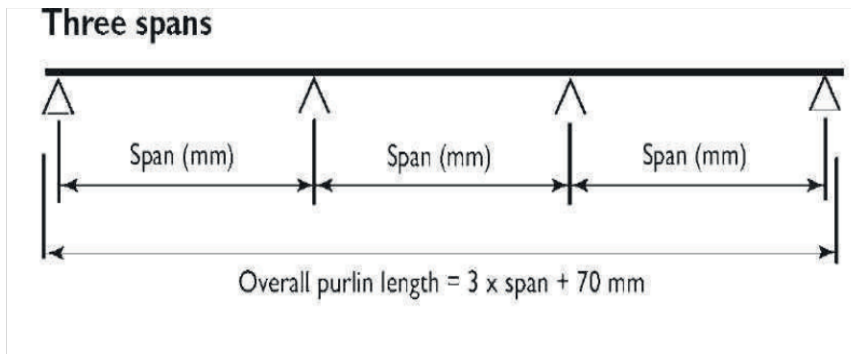

Three Continuous Span

C/Z 20015 (kN/m)

C/Z 20019 (kN/m)

C/Z 20024 (kN/m)

Bridging >	C/Z 20015 (kN/m)					C/Z 20019 (kN/m)					C/Z 20024 (kN/m)				
	IN		OUT		L/150	IN		OUT		L/150	IN		OUT		L/150
	0	1,2,3	0	1,2,3		0	1,2,3	0	1,2,3		0	1	2,3		
2100	10.83	10.83	10.83	10.83	58.42	17.77	17.77	17.77	17.77	83.25	22.44	22.44	22.44	22.44	109.93
2400	9.18	9.18	9.18	9.18	39.14	15.55	15.55	15.55	15.55	55.77	19.64	19.64	19.64	19.64	73.64
2700	7.88	7.88	7.88	7.88	27.49	13.82	13.82	13.82	13.82	39.17	17.46	17.46	17.46	17.46	51.72
3000	6.84	6.84	6.84	6.84	20.04	12.31	12.31	12.31	12.31	28.55	15.71	15.71	15.71	15.71	37.70
3300	6.00	6.00	5.00	6.00	15.06	9.80	10.64	10.64	10.64	21.45	12.81	14.28	14.28	14.28	28.33
3600	5.29	5.29	5.29	5.29	11.6	7.62	9.28	9.28	9.28	16.52	10.17	13.09	13.09	13.09	21.82
3900	4.70	4.71	4.71	4.71	9.12	6.27	8.15	8.15	8.15	13.00	8.27	12.07	11.98	12.07	17.16
SECTION BELOW EXCEED THE NORMAL DEIVERY LENGTH OF 12000 MM															
4200	4.20	4.21	4.21	4.21	7.30	5.24	7.17	7.17	7.17	10.41	6.85	10.43	9.96	10.43	13.74
4500	3.56	3.78	3.78	3.78	5.94	4.45	6.25	6.11	6.25	8.46	5.77	9.09	8.35	9.09	1.17
4800	3.05	3.41	3.41	3.41	4.89	3.81	5.49	5.11	5.49	6.99	4.89	7.99	7.05	7.99	9.27
5100	2.64	3.10	2.97	3.10	4.10	3.31	4.87	4.23	4.87	5.87	4.18	7.07	5.95	7.07	7.81
5400	2.30	2.82	2.47	2.82	3.51	2.89	4.34	3.41	4.34	4.98	3.62	6.31	4.97	6.31	6.65
5700	2.02	2.56	2.06	2.56	3.04	2.55	3.90	2.85	3.90	4.26	3.16	5.66	4.16	5.66	5.71
6000	1.78	2.31	1.74	2.31	2.65	2.26	3.52	2.47	3.52	3.67	2.78	5.11	3.52	5.07	4.95
6300	1.58	2.09	1.48	2.09	2.32	2.01	3.19	2.13	3.19	3.19	2.46	4.64	3.00	4.49	4.30

Bold capacities require grade 8.8 purlin bolts. Values above horizontal line in body of table are governed by the strength of the grade 8.8 bolt. IN = Inward load capacity. OUT = Outward load capacity L/150 = load for deflection span/150. See also: Design notes for capacity tables.

Limit state capacity tables

Three lapped spans

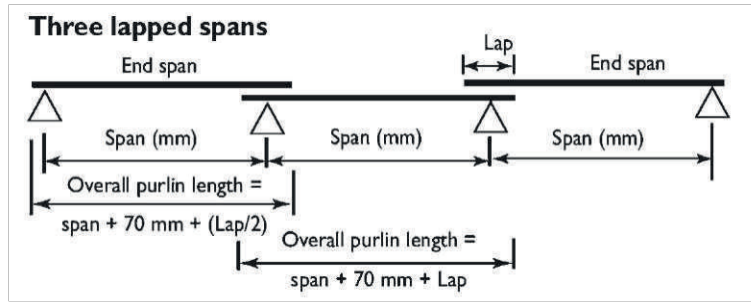

Three Lapped span: Z/C 10019 (kN/m)

Bridging >	IN			OUT				L/150
	0	1	2,3	0	1	2	3	
2100	12.16	14.65	14.65	14.65	14.65	14.65	14.7	14.96
2400	8.87	11.16	11.16	11.10	11.16	11.16	11.20	9.96
2700	6.66	8.77	8.77	8.08	8.77	8.77	8.77	6.95
3000	5.18	7.07	7.07	6.02	7.07	7.07	7.07	5.08
3300	4.14	5.83	5.83	4.54	5.83	5.83	5.83	3.82
3600	3.37	4.88	4.88	3.43	4.87	4.88	4.88	2.94
3900	2.80	4.15	4.15	2.63	3.99	4.15	4.15	2.32
4200	2.35	3.57	3.57	2.04	3.26	3.57	3.57	1.87
4500	1.99	3.10	3.10	1.61	2.69	3.10	3.10	1.51
4800	1.70	2.72	2.72	1.29	2.24	2.72	2.72	1.24
5100	1.46	2.37	2.37	1.05	1.85	2.32	2.37	1.03
5400	1.27	2.08	2.08	0.86	1.52	1.99	2.08	0.87
5700	1.10	1.84	1.85	0.72	1.28	1.70	1.85	0.74
6000	0.97	1.63	1.65	0.61	1.07	1.47	1.65	0.63
6300	0.87	1.53	1.59	0.53	0.93	1.33	1.55	0.55
6600	0.77	1.38	1.44	0.45	0.79	1.17	1.37	0.48
6900	0.69	1.24	1.32		0.68	1.01	1.22	0.42
7200	0.61	1.13	1.21		0.58	0.88	1.08	0.37
7500	0.55	1.02	1.10		0.50	0.77	0.96	0.33
7800	0.49	0.92	1.01		0.44	0.67	0.85	0.29

Bold capacities require grade 8.8 purlin bolts. Values above horizontal line in body of table are governed by the strength of the grade 8.8 bolt. IN = Inward load capacity. OUT = Outward load capacity L/150 = load for deflection span/150. See also: Design notes for capacity tables.

Limit state capacity tables

Three lapped spans

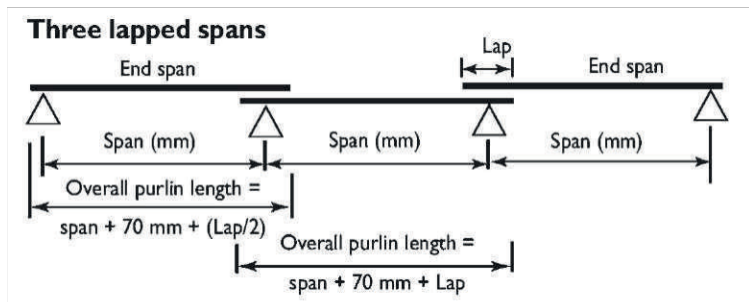

Three Lapped span: Z/C 15015 (kN/m)

Bridging >	IN			OUT				L/150
	0	1	2,3	0	1	2	3	
span								
3000	7.08	9.10	9.10	9.10	9.10	9.10	9.10	11.17
(mm)								
3300	5.64	7.49	7.49	7.49	7.49	7.49	7.49	8.35
3600	4.59	6.27	6.27	5.94	6.27	6.27	6.67	6.40
3900	3.80	5.32	5.32	4.69	5.32	5.32	5.32	5.02
4200	3.20	4.58	4.58	3.56	4.58	4.58	4.58	4.00
4500	2.72	3.98	3.98	2.87	3.98	3.98	3.98	3.27
4800	2.34	3.49	3.49	2.34	3.49	3.49	3.49	2.71
5100	2.04	3.08	3.08	1.94	3.08	3.08	3.08	2.27
5400	1.78	2.74	2.74	1.61	2.74	2.74	2.74	1.92
5700	1.57	2.46	2.46	1.34	2.46	2.46	2.46	1.64
6000	1.39	2.21	2.21	1.12	2.21	2.21	2.21	1.41
6300	1.24	2.00	2.00	0.95	2.00	2.00	2.00	1.23
6600	1.11	1.82	1.82	0.80	1.82	1.82	1.82	1.07
6900	1.00	1.67	1.67	0.68	1.67	1.65	1.67	0.95
7200	0.89	1.53	1.53	0.58	1.53	1.47	1.53	0.84
7500	0.80	1.39	1.39	0.50	1.39	1.30	1.39	0.75
7800	0.72	1.28	1.28	0.43	1.28	1.16	1.28	0.67
8100	0.65	1.17	1.17		1.17	1.02	1.17	0.60
8400	0.59	1.08	1.08		1.08	0.91	1.08	0.54
8700	0.54	1.00	1.00		0.99	0.80	0.99	0.49
9000	0.49	0.93	0.93		0.90	0.70	0.90	0.44
9300	0.45	0.89	0.92		0.85	0.65	0.85	0.40
9600	0.42	0.82	0.86		0.78	0.59	0.78	0.37
9900		0.76	0.80		0.70	0.53	0.70	0.33

Bold capacities require grade 8.8 purlin bolts. Values above horizontal line in body of table are governed by the strength of the grade 8.8 bolt. IN = Inward load capacity. OUT = Outward load capacity L/150 = load for deflection span/150. See also: Design notes for capacity tables.

Limit state capacity tables

Three lapped spans

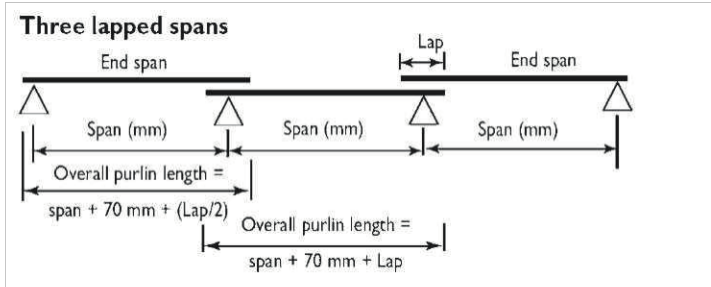

Three lapped span: Z/C 15019 (kN/m)

Three Lapped span: Z/C 15024 (kN/m)

Bridging >	IN				OUT				L/150	IN				OUT				L/150
	0	1	2	3	0	1	2	3		0	1	2	3	0	1	2	3	
Span 3000	9.20	12.83	12.83	12.83	12.69	12.83	12.83	12.83	14.57	11.31	18.08	18.08	18.08	18.00	18.08	18.08	18.08	19.43
(mm) 3300	7.22	10.56	10.56	10.56	9.94	10.56	10.56	10.56	10.9	8.87	14.88	14.88	14.88	13.94	14.88	14.88	14.88	14.53
3600	5.82	8.84	8.84	8.84	7.90	8.84	8.84	8.84	8.36	7.01	12.46	12.46	12.46	1.97	12.46	12.46	12.46	11.14
3900	4.78	7.51	7.51	7.51	6.33	7.51	7.51	7.51	6.54	5.71	10.58	10.58	10.58	8.75	10.58	10.58	10.58	8.73
4200	4.00	6.45	6.45	6.45	5.05	6.45	6.45	6.45	5.23	4.74	9.09	9.09	9.09	6.87	9.09	9.09	9.09	6.98
4500	3.39	5.61	5.61	5.61	4.00	5.60	5.61	5.61	4.29	3.99	7.90	7.90	7.90	5.39	7.90	7.90	7.90	5.68
4800	2.91	4.92	4.92	4.92	3.21	4.76	4.92	4.92	3.57	3.41	6.92	6.92	6.92	4.29	6.74	6.92	6.92	4.70
5100	2.51	4.34	4.34	4.34	2.62	4.07	4.34	4.34	3.00	2.49	6.07	6.12	6.12	3.46	5.73	6.12	6.12	3.93
5400	2.19	3.86	3.87	3.87	2.15	3.50	3.87	3.87	2.55	2.56	5.31	5.45	5.45	2.82	4.9	5.45	5.45	3.33
5700	1.92	3.42	3.46	3.46	1.76	3.03	3.46	3.46	2.19	2.24	4.68	4.88	4.88	2.33	4.21	4.88	4.88	2.28
6000	1.69	3.05	3.12	3.12	1.47	2.62	3.12	3.12	1.88	1.98	4.15	4.40	4.40	1.95	3.64	4.40	4.40	2.42
6300	1.50	2.73	2.83	2.83	1.23	2.25	2.77	2.83	1.62	1.76	3.71	3.98	3.98	1.64	3.13	3.93	3.98	2.08
6600	1.33	2.46	2.57	2.57	1.04	1.94	2.46	2.57	1.41	1.58	3.33	3.62	3.62	1.39	2.66	3.48	3.62	1.81
6900	1.19	2.23	2.35	2.35	0.89	1.66	2.19	2.35	1.24	1.41	3.00	3.31	3.31	1.19	2.27	3.08	3.31	1.58
7200	1.07	2.03	2.15	2.16	0.76	1.44	1.96	2.16	1.09	1.28	2.72	3.04	3.04	1.03	1.95	2.75	3.04	1.39
7500	0.97	1.84	1.96	1.96	0.66	1.25	1.75	1.96	0.97	1.15	2.46	2.77	2.77	0.89	1.68	2.44	2.77	1.22
7800	0.87	1.67	1.80	1.80	0.57	1.09	1.56	1.77	0.86	1.05	2.23	2.53	2.53	0.78	1.46	2.17	2.51	1.09
8100	0.79	1.52	1.65	1.65	0.50	0.96	1.40	1.60	0.77	0.96	2.04	2.33	2.33	0.69	1.28	1.95	2.26	0.97
8400	0.72	1.40	1.52	1.52	0.44	0.84	1.25	1.45	0.69	0.87	1.86	2.14	2.14	0.61	1.12	1.74	1.85	0.87
8700	0.65	1.28	1.41	1.41	0.74	1.12	1.31	1.31	0.62	0.80	1.71	1.98	1.98	0.54	0.99	1.55	1.68	0.78
9000	0.60	1.18	1.31	1.31	0.65	1.00	1.20	1.20	0.56	0.73	1.58	1.84	1.84	0.48	0.87	1.39	1.60	0.70
9300	0.55	1.14	1.29	1.29	0.59	0.91	1.14	1.14	0.51	0.69	1.51	1.82	1.82	0.44	0.79	1.25	1.46	0.64
9600	0.51	1.06	1.21	1.21	0.52	0.82	1.05	1.05	0.47	0.63	1.40	1.70	1.71	0.71	1.12	1.33	1.33	0.59
9900	0.47	0.98	1.13	1.13	0.47	0.73	0.96	0.96	0.42	0.58	1.30	1.58	1.59	0.63	1.00	1.22	1.22	0.53
10200	0.43	0.91	1.05	1.06	0.42	0.66	0.87	0.87	0.39	0.54	1.20	1.47	1.49	0.57	0.90	1.11	1.11	0.49
10500	0.40	0.85	0.97	0.99	0.60	0.79	0.79	0.79	0.35	0.50	1.12	1.36	1.39	0.51	0.81	1.01	1.01	0.45

Bold capacities require grade 8.8 purlin bolts. Values above horizontal line in body of table are governed by the strength of the grade 8.8 bolt. IN = Inward load capacity. OUT = Outward load capacity L/150 = load for deflection span/150. See also: Design notes for capacity tables.

Limit state capacity tables

Three lapped spans

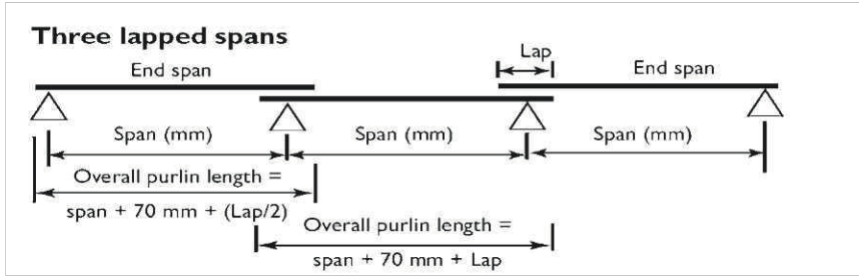

Three Lapped span: C/Z 20019 (kN/m)

Three lapped span: C/Z 20024 (kN/m)

Bridging >	IN		OUT				L/150	IN		OUT				L/150		
	0	1	2,3	0	1	2		3	0	1	2,3	0	1		2	3
Span 3000	13.75	18.79	18.79	18.79	18.79	18.79	18.79	31.46	18.42	19.78	19.78	19.78	19.78	19.78	19.78	41.54
(mm) 3300	10.77	15.47	15.47	15.47	15.47	15.47	15.47	23.52	14.22	17.99	17.99	17.99	17.99	17.99	17.99	31.06
3600	8.66	12.95	12.95	12.95	12.95	12.95	12.95	18.04	11.13	16.50	16.50	16.50	16.50	16.50	16.50	23.82
3900	7.10	11.00	11.00	11.00	11.00	11.00	11.00	14.13	8.94	15.24	15.24	15.24	15.24	15.24	15.24	18.66
4200	5.93	9.45	9.45	9.18	9.45	9.45	9.45	11.27	7.32	13.74	13.74	12.55	13.74	13.74	13.74	14.88
4500	5.02	8.21	8.21	7.52	8.21	8.21	8.21	9.13	6.09	11.94	11.94	10.41	11.94	11.94	11.94	12.06
4800	4.29	7.20	7.20	6.07	7.20	7.20	7.20	7.50	5.15	10.47	10.47	8.58	10.47	10.47	10.47	9.90
5100	3.69	6.36	6.36	4.84	6.36	6.36	6.36	6.23	4.41	9.25	9.25	6.98	9.25	9.25	9.25	8.23
5400	3.21	5.66	5.66	4.04	5.66	5.66	5.66	5.24	3.81	8.23	8.23	5.75	8.23	8.23	8.23	6.93
5700	2.81	5.07	5.07	3.41	5.07	5.07	5.07	4.47	3.32	7.27	7.38	4.80	7.25	7.38	7.38	5.94
6000	2.48	4.57	4.57	2.9	4.57	4.57	4.57	3.85	2.92	6.46	6.64	4.02	6.35	6.64	6.64	5.13
6300	2.20	4.14	4.14	2.48	4.09	4.14	4.14	3.34	2.59	5.77	6.02	3.36	5.60	6.02	6.02	4.46
6600	1.97	3.77	3.77	2.10	3.59	3.77	3.77	2.91	2.31	5.18	5.47	2.84	4.95	5.47	5.47	3.91
6900	1.77	3.44	3.44	1.80	3.15	3.44	3.44	2.56	2.07	4.67	5.00	2.42	4.39	5.00	5.00	3.45
7200	1.59	3.16	3.16	1.55	2.74	3.16	3.16	2.26	1.86	4.24	4.59	2.07	3.88	4.59	4.59	3.04
7500	1.44	2.88	2.88	1.35	2.30	2.88	2.88	2.01	1.69	3.83	4.18	1.78	3.40	4.17	4.18	2.69
7800	1.31	2.63	2.63	1.17	2.03	2.63	2.63	1.79	1.53	3.47	3.83	1.55	2.97	3.75	3.83	2.40
8100	1.19	2.42	2.42	1.02	1.79	2.42	2.42	1.61	1.40	3.17	3.52	1.35	2.60	3.39	3.52	2.14
8400	1.09	2.22	2.23	0.89	1.59	2.23	2.23	1.45	1.28	2.90	3.24	1.18	2.30	3.07	3.24	1.93
8700	1.00	2.03	2.06	0.78	1.42	2.03	2.06	1.31	1.17	2.66	3.00	1.04	2.04	2.78	3.00	1.74
9000	0.92	1.87	1.91	0.69	1.27	1.84	1.91	1.19	1.08	2.45	2.78	0.92	1.81	2.54	2.78	1.58
9300	0.86	1.79	1.89	0.62	1.18	1.74	1.89	1.09	1.00	2.35	2.75	0.84	1.66	2.42	2.73	1.44
9600	0.79	1.66	1.78	0.56	1.07	1.56	1.78	1.00	0.93	2.17	2.58	0.75	1.47	2.21	2.52	1.32
9900	0.73	1.54	1.66	0.50	0.96	1.41	1.66	0.91	0.86	2.01	2.41	0.67	1.32	2.00	2.32	1.20
10200	0.68	1.43	1.55	0.45	0.86	1.23	1.55	0.84	0.80	1.86	2.25	0.60	1.18	1.82	2.14	1.10
10500	0.63	1.33	1.45	0.40	0.78	1.12	1.44	0.77	0.74	1.73	2.10	0.54	1.06	1.64	1.97	1.00
10800	0.58	1.24	1.36	0.36	0.70	1.02	1.33	0.71	0.69	1.61	1.96	0.49	0.95	1.49	1.82	0.92
SECTION BELOW EXCEED THE NORMAL DEIVERY LENGTH OF 1200 MM																
11100	0.54	1.15	1.28	0.32	0.64	0.93	1.23	0.66	0.65	1.50	1.84	0.45	0.86	1.36	1.69	0.85
11400	0.5	1.08	1.21	0.28	0.58	0.86	1.13	0.61	0.60	1.40	1.72	0.41	0.78	1.24	1.57	0.78
11700	0.47	1.00	1.14	0.24	0.53	0.79	1.05	0.56	0.56	1.31	1.62	0.37	0.71	1.13	1.46	0.72
12000	0.44	0.94	1.08	0.20	0.48	0.73	0.96	0.52	0.53	1.23	1.52	0.33	0.65	1.04	1.36	0.67

Bold capacities require grade 8.8 purlin bolts. Values above horizontal line in body of table are governed by the strength of the grade 8.8 bolt. IN = Inward load capacity. OUT = Outward load capacity L/150 = load for deflection span/150. See also: Design notes for capacity tables.

Limit state capacity tables

Three lapped spans

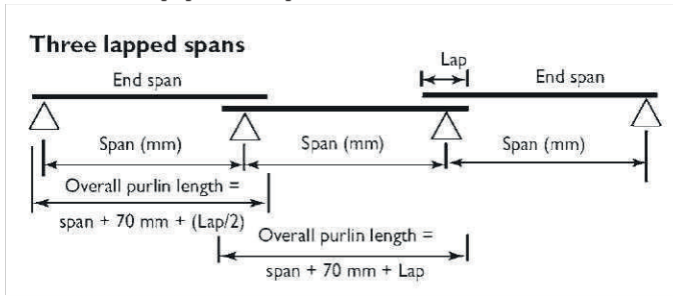

Three Lapped span: C/Z 25019 (kN/m)

		IN			OUT				L/150
Bridging >		0	1	2,3	0	1	2	3	
Span	3000	17.28	17.28	17.28	17.28	17.28	17.28	17.28	51.10
(mm)	3300	13.93	15.00	15.00	15.00	15.00	15.00	15.00	38.21
	3600	11.15	13.16	13.16	13.16	13.16	13.16	13.16	29.30
	3900	9.12	11.64	11.64	11.64	11.64	11.64	11.64	22.95
	4200	7.59	10.36	10.36	10.36	10.36	10.36	10.36	18.3
	4500	6.38	9.28	9.28	9.28	9.28	9.28	9.28	14.83
	4800	5.42	8.35	8.35	7.80	8.35	8.35	8.35	12.18
	5100	4.65	7.55	7.55	6.42	7.55	7.55	7.55	10.12
	5400	4.04	6.85	6.85	5.34	6.85	6.85	6.85	8.50
	5700	3.53	6.24	6.24	4.49	6.24	6.24	6.24	7.21
	6000	3.12	5.70	5.70	3.80	5.70	5.70	5.70	6.17
	6300	2.77	5.23	5.23	3.23	5.23	5.23	5.23	5.32
	6600	2.47	4.78	4.78	2.73	4.78	4.78	4.78	4.61
	6900	2.22	4.37	4.37	2.33	4.19	4.37	4.37	4.04
	7200	2.00	4.01	4.01	2.01	3.63	4.01	4.01	3.60
	7500	1.81	3.65	3.65	1.74	3.06	3.65	3.65	3.23
	7800	1.64	3.34	3.34	1.51	2.69	3.34	3.34	2.91
	8100	1.49	3.07	3.07	1.31	2.37	3.07	3.07	2.63
	8400	1.37	2.28	2.28	1.14	2.10	2.28	2.28	2.38
	8700	1.25	2.62	2.62	1.00	1.87	2.62	2.62	2.15
	9000	1.15	2.43	2.43	0.88	1.67	2.43	2.43	1.95
	9300	1.07	2.37	2.40	0.80	1.55	2.31	2.40	1.78
	9600	0.99	2.19	2.25	0.71	1.40	2.07	2.25	1.63
	9900	0.91	2.02	2.10	0.63	1.25	1.80	2.10	1.49
	10200	0.84	1.87	1.96	0.56	1.12	1.63	1.96	1.36
	10500	0.78	1.73	1.84	0.51	1.00	1.48	1.84	1.26
	10800	0.73	1.61	1.73	0.46	0.91	1.35	1.73	1.16
SECTION BELOW EXCEED THE NORMAL DELIVERY LENGTH OF 12000 MM									
	11100	0.67		1.62	0.41	0.82	1.24	1.62	1.07
	11400	0.63		1.53		0.75	1.13	1.52	0.99
	11700	0.58		1.44		0.68	1.04	1.39	0.92
	12000	0.54		1.37		0.62	0.95	1.28	0.86

Bold capacities require grade 8.8 purlin bolts. Values above horizontal line in body of table are governed by the strength of the grade 8.8 bolt. IN = Inward load capacity. OUT = Outward load capacity L/150 = load for deflection span/150. See also: Design notes for capacity tables.

Limit state capacity tables

Three lapped spans

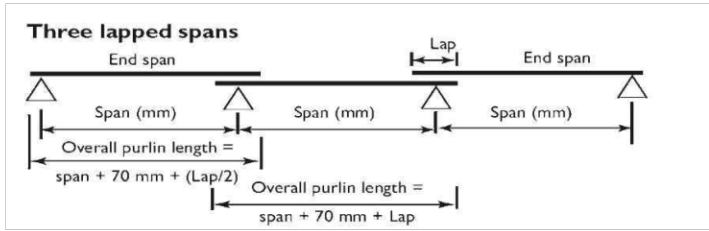

Three lapped span: C/Z 25024 (kN/m)

		IN			OUT				L/150
Bridging >		0	1	2,3	0	1	2	3	
Span	3000	19.78	19.78	19.78	19.78	19.78	19.78	19.78	70.48
(mm)	3300	17.87	17.99	17.99	17.99	17.99	17.99	17.99	52.70
	3600	13.95	16.50	16.50	16.50	16.50	16.50	16.50	40.41
	3900	11.16	15.24	15.24	15.24	15.24	15.24	15.24	31.65
	4200	9.12	14.16	14.16	14.16	14.16	14.16	14.16	25.24
	4500	7.58	13.22	13.22	13.22	13.22	13.22	13.22	20.45
	4800	6.40	12.40	12.40	11.27	12.40	12.40	12.40	16.80
	5100	5.46	11.68	11.68	9.13	11.68	11.68	11.68	13.96
	5400	4.72	10.55	10.55	7.50	10.55	10.55	10.55	11.73
	5700	4.11	9.45	9.45	6.24	9.45	9.45	9.45	9.95
	6000	3.61	8.52	8.52	5.20	8.52	8.52	8.52	8.51
	6300	3.20	7.67	7.71	4.35	7.48	7.71	7.71	7.33
	6600	2.85	6.87	7.02	3.66	6.59	7.02	7.02	6.38
	6900	2.55	6.19	6.41	3.11	5.82	6.41	6.41	5.61
	7200	2.29	5.60	5.88	2.65	5.10	5.88	5.88	4.97
	7500	2.07	5.06	5.36	2.28	4.44	5.36	5.36	4.42
	7800	1.88	4.58	4.91	1.90	3.87	4.91	4.91	3.95
	8100	1.71	4.17	4.51	1.72	3.39	4.51	4.51	3.55
	8400	1.57	3.81	4.15	1.50	2.98	4.10	4.15	3.20
	8700	1.44	3.49	3.84	1.32	2.64	3.72	3.84	2.89
	9000	1.32	3.20	3.56	1.17	2.35	3.38	3.56	2.61
	9300	1.23	3.04	3.53	1.05	2.14	3.21	3.53	2.39
	9600	1.13	2.81	3.31	0.94	1.90	2.91	3.31	2.18
	9900	1.05	2.59	3.08	0.84	1.69	2.63	3.08	1.99
	10200	0.97	2.39	2.88	0.75	1.51	2.37	2.86	1.82
	10500	0.91	2.21	2.70	0.68	1.36	2.14	2.64	1.67
	10800	0.84	2.05	2.53	0.61	1.22	1.94	2.44	1.54
SECTION BELOW EXCEED THE NORMAL DELIVERY LENGTH OF 12000 MM									
	11100	0.79	1.91	2.38	0.55	1.10	1.76	2.25	1.42
	11400	0.73	1.78	2.25	0.50	1.00	1.61	2.09	1.31
	11700	0.69	1.66	2.12	0.46	0.90	1.47	1.94	1.21
	12000	0.64	1.56	2.00	0.42	0.82	1.34	1.79	1.13

Bold capacities require grade 8.8 purlin bolts. Values above horizontal line in body of table are governed by the strength of the grade 8.8 bolt. IN = Inward load capacity. OUT = Outward load capacity

L/150 = load for deflection span/150. See also: Design notes for capacity tables.

Limit state capacity tables

Three lapped spans

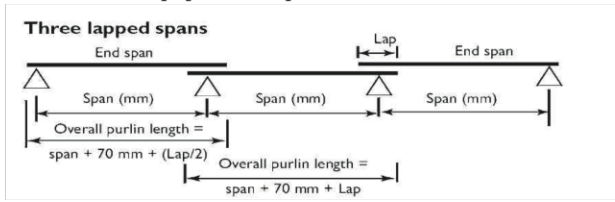

THREE LAPPED SPANS

Bridging > Span mm	C/Z 30024 (kN/m)									L/150	C/Z 30024/30030 (kN/m)								L/150
	INWARD				OUTWARD				L/150		INWARD				OUTWARD				
	0	1	2	3	0	1	2	3			0	1	2,3	0	1	2	3		
6000	5.36	10.31	10.31	10.31	10.12	10.31	10.31	10.31	14.12	5.96	11.20	11.20	11.20	11.20	11.20	11.20	18.35		
6300	4.70	9.50	9.50	9.50	8.59	9.50	9.50	9.50	12.17	5.20	10.24	10.24	10.24	10.24	10.24	10.24	15.81		
6600	4.15	8.77	8.77	8.77	7.29	8.77	8.77	8.77	10.56	4.58	9.40	9.40	8.82	9.40	9.40	9.40	13.73		
6900	3.69	8.12	8.12	8.12	6.35	8.12	8.12	8.12	9.22	4.06	8.65	8.65	7.58	8.65	8.65	8.65	11.99		
7200	3.30	7.54	7.54	7.54	5.57	7.54	7.54	7.54	8.10	3.62	7.99	7.99	6.47	7.99	7.99	7.99	10.53		
7500	2.97	7.01	7.01	7.01	4.88	7.01	7.01	7.01	7.16	3.25	7.40	7.40	5.68	7.40	7.40	7.40	9.38		
7800	2.68	6.53	6.53	6.53	4.25	6.53	6.53	6.53	6.35	2.93	6.87	6.87	5.01	6.87	6.87	6.87	8.39		
8100	2.43	6.10	6.10	6.10	3.73	6.10	6.10	6.10	5.73	2.66	6.38	6.38	4.45	6.38	6.38	6.38	7.55		
8400	2.21	5.66	5.71	5.71	3.28	5.62	5.71	5.71	5.20	2.42	5.88	5.88	3.97	5.88	5.88	5.88	6.81		
8700	2.03	5.16	5.28	5.28	2.88	5.06	5.28	5.28	4.73	2.21	5.44	5.44	3.53	5.44	5.44	5.44	6.17		
9000	1.86	4.73	4.89	4.89	2.53	4.57	4.89	4.89	4.31	2.02	5.04	5.04	3.14	5.04	5.04	5.04	5.61		
9300	1.72	4.51	4.85	4.85	2.29	4.22	4.85	4.85	3.95	1.88	4.89	5.04	2.89	4.94	5.04	5.04	5.15		
9600	1.59	4.14	4.54	4.54	2.04	3.79	4.54	4.54	3.60	1.73	4.50	4.69	2.57	4.00	4.69	4.69	4.70		
9900	1.47	3.80	4.24	4.24	1.81	3.35	4.24	4.24	3.29	1.60	4.15	4.37	2.29	4.49	4.37	4.37	4.30		
10200	1.37	3.50	3.96	3.96	1.62	3.04	3.96	3.96	3.02	1.49	3.84	4.08	2.06	3.70	4.08	4.08	3.94		
10500	1.27	3.24	3.71	3.71	1.46	2.77	3.71	3.71	2.77	1.38	3.55	3.82	1.85	3.35	3.82	3.82	3.62		
10800	1.19	3.00	3.48	3.48	1.31	2.53	3.48	3.48	2.55	1.29	3.28	3.59	1.67	3.05	3.59	3.59	3.34		

SECTION BELOW EXCEED THE NORMAL DELIVERY LENGTH OF 12000 MM

11100	1.11	2.78	3.27	3.27	1.18	2.32	3.27	3.27	2.36	1.20	3.05	3.38	1.51	2.77	3.38	3.38	3.08
11400	1.04	2.59	3.09	3.09	1.07	2.13	3.04	3.09	2.18	1.13	2.83	3.18	1.37	2.49	3.18	3.18	2.84
11700	0.97	2.42	2.91	2.91	0.97	1.96	2.81	2.91	2.02	1.05	2.64	3.00	1.24	2.30	3.00	3.00	2.63
12000	0.91	2.26	2.75	2.75	0.88	1.80	2.61	2.75	1.88	0.99	2.47	2.84	1.14	2.21	2.84	2.84	2.43
12300	0.87	2.14	2.78	2.78	0.83	1.71	2.49	2.78	1.77	0.94	2.37	3.00	1.07	2.08	2.69	3.00	2.3
12600	0.82	2.02	2.65	2.65	0.76	1.57	2.30	2.65	1.65	0.89	2.22	2.84	0.98	1.93	2.75	2.84	2.13
12900	0.77	1.90	2.52	2.52	0.70	1.44	2.12	2.52	1.55	0.84	2.08	2.69	0.9	1.79	2.56	2.69	1.99
13200	0.73	1.80	2.41	2.41	0.64	1.32	1.97	2.41	1.45	0.79	1.96	2.55	0.83	1.65	2.39	2.55	1.85
13500	0.69	1.70	2.30	2.30	0.59	1.21	1.80	2.30	1.36	0.75	1.85	2.42	0.76	1.52	2.22	2.42	1.73
13800	0.65	1.61	2.20	2.20	0.54	1.12	1.68	2.17	1.28	0.71	1.75	2.30	0.70	1.41	2.06	2.30	1.62
14100	0.62	1.53	2.11	2.11	0.50	1.03	1.57	2.04	1.20	0.67	1.65	2.19	0.65	1.31	1.91	2.19	1.52
14400	0.58	1.45	2.02	2.02	0.46	0.95	1.47	1.92	1.14	0.64	1.56	2.08	0.60	1.22	1.78	2.08	1.42
14700	0.56	1.38	1.93	1.93	0.43	0.88	1.37	1.81	1.07	0.60	1.48	1.99	0.56	1.13	1.66	1.99	1.34
15000	0.53	1.31	1.84	1.84	0.40	0.81	1.29	1.69	1.01	0.57	1.41	1.90	0.52	1.04	1.55	1.90	1.26
15300	0.50	1.24	1.76	1.76		0.75	1.21	1.58	0.95	0.55	1.34	1.82	0.49	0.97	1.42	1.82	1.18
15600	0.48	1.18	1.67	1.68		0.70	1.13	1.48	0.90	0.52	1.27	1.74	0.45	0.90	1.34	1.72	1.12
15900	0.45	1.13	1.59	1.61		0.65	1.06	1.38	0.85	0.50	1.21	1.66	0.42	0.84	1.26	1.63	1.05
16200	0.43	1.07	1.52	1.55		0.61	1.00	1.30	0.81	0.47	1.16	1.60	0.40	0.78	1.19	1.54	1.00
16500	0.41	1.03	1.45	1.49		0.57	0.93	1.22	0.76	0.45	1.10	1.53		0.73	1.12	1.46	0.94
16800		0.98	1.39	1.43		0.53	0.88	1.13	0.73	0.43	1.05	1.47		0.68	1.06	1.38	0.89
17100		0.94	1.33	1.37		0.49	0.82	1.06	0.69	0.41	1.01	1.41		0.64	1.00	1.30	0.85
17400		0.90	1.27	1.32		0.46	0.78	1.01	0.65		0.96	1.36		0.60	0.94	1.23	0.80

Limit state capacity tables

Three lapped spans

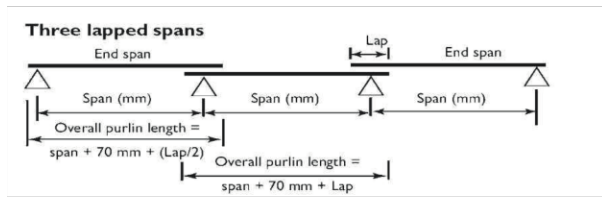

Three lapped span: C/Z 30030 (kN/m)

Bridging >		IN				OUT				L/150
		0	1	2	3	0	1	2	3	
span	6000	6.31	16.68	1.68	1.68	14.28	16.68	16.68	16.68	18.83
(mm)	6300	5.51	15.10	15.10	15.10	12.15	15.10	15.10	15.10	16.23
	6600	4.85	13.69	13.74	13.74	10.39	13.74	13.74	13.74	14.09
	6900	4.30	12.31	12.55	12.55	8.83	12.55	12.55	12.55	12.3
	7200	3.83	11.12	11.51	11.51	7.56	11.51	11.51	11.51	10.81
	7500	3.44	10.01	10.49	10.49	6.50	10.47	10.49	10.49	9.55
	7800	3.10	9.05	9.60	9.60	5.62	9.41	9.60	9.60	8.53
	8100	2.81	8.21	8.82	8.82	4.89	8.49	8.82	8.82	7.66
	8400	2.55	7.48	8.13	8.13	4.27	7.68	8.13	8.13	6.92
	8700	2.33	6.84	7.52	7.52	3.75	6.97	7.52	7.52	6.27
	9000	2.14	6.28	6.98	6.98	3.31	6.34	6.98	6.98	5.70
	9300	1.98	5.97	6.91	6.91	3.00	6.00	6.91	6.91	5.23
	9600	1.83	5.47	6.48	6.48	2.67	5.40	6.48	6.48	4.79
	9900	1.69	5.02	6.04	6.04	2.38	4.87	6.04	6.04	4.40
	10200	1.57	4.61	5.64	5.64	2.13	4.40	5.63	5.64	4.03
	10500	1.46	4.26	5.29	5.29	1.91	3.90	5.20	5.29	3.70
	10800	1.36	3.94	4.96	4.96	1.73	3.58	4.82	4.96	3.41

SECTION BELOW EXCEED THE NORMAL DELIVERY LENGTH OF 12000 MM

11100	1.27	3.66	4.67	4.67	1.56	3.23	4.47	4.67	3.15
11400	1.19	3.40	4.40	4.40	1.41	2.93	4.16	4.40	2.92
11700	1.12	3.16	4.15	4.15	1.29	2.66	3.87	4.15	2.70
12000	1.05	2.94	3.92	3.92	1.17	2.42	3.61	3.92	2.50
12300	10.00	2.80	3.88	3.97	1.10	2.27	3.52	3.97	2.36
12600	0.94	2.62	3.67	3.78	1.01	2.08	3.28	3.76	2.19
12900	0.89	2.45	3.47	3.60	0.93	1.90	3.03	3.54	2.04
13200	0.84	2.30	3.29	3.44	0.85	1.75	2.81	3.33	1.91
13500	0.80	2.16	3.12	3.28	0.78	1.61	2.61	3.15	1.78
13800	0.76	2.04	2.90	3.14	0.72	1.48	2.43	2.97	1.66
14100	0.72	1.92	2.81	3.00	0.67	1.36	2.25	2.81	1.56
14400	0.68	1.81	2.68	2.88	0.62	1.26	2.08	2.66	1.46
14700	0.65	1.71	2.54	2.75	0.58	1.17	1.93	2.50	1.37
15000	0.62	1.62	2.42	2.62	0.54	1.08	1.79	2.37	1.29
15300	0.59	1.53	2.30	2.51	0.50	1.00	1.66	2.23	1.22
15600	0.56	1.46	2.19	2.39	0.47	0.93	1.55	2.10	1.15
15900	0.53	1.38	2.09	2.28	0.44	0.87	1.44	1.97	1.08
16200	0.51	1.31	1.99	2.17	0.41	0.81	1.34	1.85	1.02
16500	0.49	1.25	1.90	2.08		0.76	1.25	1.74	0.97
16800	0.47	1.19	1.82	1.99		0.71	1.17	1.64	0.92
17100	0.45	1.13	1.74	1.90		0.66	1.10	1.54	0.87
17400	0.43	1.08	1.66	1.82		0.62	1.03	1.46	0.82

Bold capacities require grade **8.8** purlin bolts. Values above horizontal line in body of table are governed by the strength of the grade **8.8** bolt. IN = Inward load capacity. OUT = Outward load capacity L/150 = load for deflection span/150 . See also: Design notes for capacity tables.

Limit state capacity tables

Four continuous spans

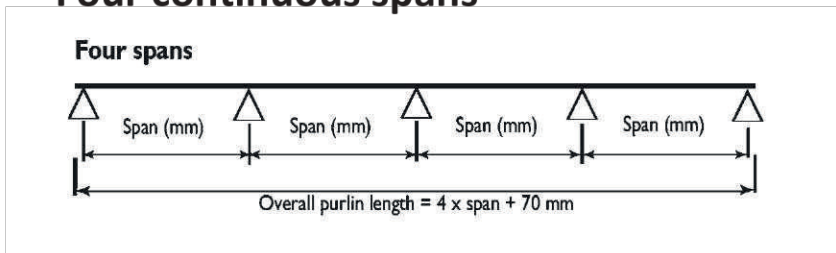

Four continuous span

Z/C10019 (kN/m)

Z/C15015 (kN/m)

Z/C15019 (kN/m)

Z/C15024 (kN/m)

Bridging >	Z/C10019 (kN/m)			L/150	Z/C15015 (kN/m)			L/150	Z/C15019 (kN/m)			L/150	Z/C15024 (kN/m)			L/150
	IN	OUT			IN	OUT			IN	OUT			IN	OUT		
	0,1,2,3	0	1,2,3		0,1,2,3	0	1,2,3		0,1,2,3	0	1,2,3		0,1,2,3	0	1,2,3	
Span 2100	10.26	10.26	10.26	14.51	11.36	11.36	11.36	31.49	17.10	17.10	17.10	41.09	21.60	21.60	21.6	54.80
(mm) 2400	7.85	7.85	7.85	9.72	9.22	9.22	9.22	21.10	13.66	13.66	13.66	27.53	18.90	18.90	18.90	36.71
2700	6.20	5.34	6.20	6.87	7.62	7.62	7.62	14.82	11.04	11.04	11.04	19.33	15.59	15.59	15.59	25.78
3000	5.03	3.75	5.03	5.02	6.36	6.36	6.36	10.80	8.96	8.96	8.96	14.09	12.62	12.62	12.62	18.80
SECTION BELOW EXCEED THE NORMAL DELIVERY LENGTH OF 12000 MM																
3300	4.15	2.49	4.15	3.79	5.25	5.02	5.25	8.12	7.41	6.97	7.14	10.59	10.43	9.47	10.43	14.12
3600	3.49	1.80	3.49	2.94	4.41	3.76	4.41	6.25	6.22	5.10	6.22	8.16	8.77	6.80	8.77	10.88
3900	2.97	1.33	2.97	2.33	3.76	2.82	3.76	4.92	5.30	3.74	5.30	6.42	7.47	5.00	7.47	8.56

Z/C20015 (kN/m)

Z/20019 (kN/m)

Z/C20024 (kN/m)

Bridging →	Z/C20015 (kN/m)			L/150	Z/20019 (kN/m)			L/150	Z/C20024 (kN/m)			L/150
	IN	OUT			IN	OUT			IN	OUT		
	0,1,2,3	0	1,2,3		0,1,2,3	0	1,2,3		0,1,2,3	0	1,2,3	
Span 2100	10.57	10.57	10.57	62.26	17.10	17.10	17.10	88.71	21.60	21.60	21.60	117.14
(mm) 2400	8.92	8.92	8.92	41.71	14.96	14.96	14.96	59.43	18.90	18.90	18.90	78.47
2700	7.64	7.64	7.64	29.29	13.30	13.30	13.30	41.74	16.80	16.80	16.80	55.11
3000	6.62	6.62	6.62	21.35	11.18	11.18	11.18	30.43	15.12	15.12	15.12	40.18
3300	5.78	5.78	5.78	16.04	10.18	10.18	10.18	22.86	13.75	13.75	13.75	30.19
SECTION BELOW EXCEED THE NORMAL DELIVERY LENGTH OF 12000 MM												
3600	5.09	5.09	5.09	12.36	8.85	8.85	8.85	17.61	12.60	12.60	12.60	23.25
3900	4.52	4.52	4.52	9.72	7.76	7.70	7.76	13.85	11.26	11.10	11.26	18.29

Bold capacities require grade 8.8 purlin bolts. Values above horizontal line in body of table are governed by the strength of the grade 8.8 bolt. IN = Inward load capacity. OUT = Outward load capacity L/150 = load for deflection span/150. See also: Design notes for capacity tables.

Limit state capacity tables

Four lapped spans

Four lapped spans

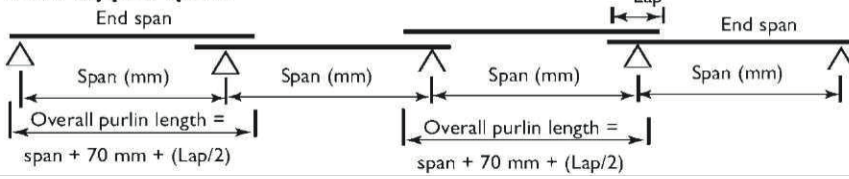

Four lapped span: C/Z 10019 (kN/m)

Bridging >	Span (mm)	IN			OUT			L/150
		0	1	2,3	0	1	2	
2100	12.6	15.57	15.57	15.57	15.57	15.57	15.57	16.7
2400	9.10	11.82	11.82	11.71	11.82	11.82	11.82	11.06
2700	6.83	9.27	9.27	8.61	9.27	9.27	9.27	7.69
3000	5.31	7.47	7.47	6.41	7.47	7.47	7.47	5.56
3300	4.22	6.04	6.04	4.83	6.04	6.04	6.04	4.17
3600	3.40	4.90	4.90	3.60	4.90	4.90	4.90	3.20
3900	2.80	4.05	4.05	2.77	3.99	4.05	4.05	2.51
4200	2.34	3.41	3.14	2.15	3.25	3.14	3.14	2.01
4500	1.98	2.91	2.19	1.69	2.66	2.19	2.19	1.64
4800	1.70	2.51	2.51	1.36	2.20	2.51	2.51	1.36
5100	1.46	2.19	2.19	1.10	1.84	2.19	2.19	1.13
5400	1.27	1.92	1.92	0.91	1.55	1.90	1.92	0.95
5700	1.11	1.71	1.71	0.76	1.30	1.65	1.71	0.80
6000	0.98	1.52	1.52	0.64	1.10	1.43	1.52	0.69
6300	0.89	1.48	1.51	0.56	0.98	1.33	1.51	0.61
6600	0.79	1.32	1.36	0.48	0.83	1.16	1.34	0.53
6900	0.71	1.18	1.23	0.42	0.71	1.01	1.18	0.46
7200	0.63	1.06	1.12		0.61	0.89	1.05	0.40
7500	0.57	0.96	1.02		0.53	0.77	0.93	0.35
7800	0.51	0.87	0.93		0.46	0.68	0.83	0.31

Bold capacities require grade 8.8 purlin bolts. Values above horizontal line in body of table are governed by the strength of the grade 8.8 bolt. IN = Inward load capacity. OUT = Outward load capacity L/150 = load for deflection span/150. See also: Design notes for capacity tables.

Limit state capacity tables

Four lapped spans

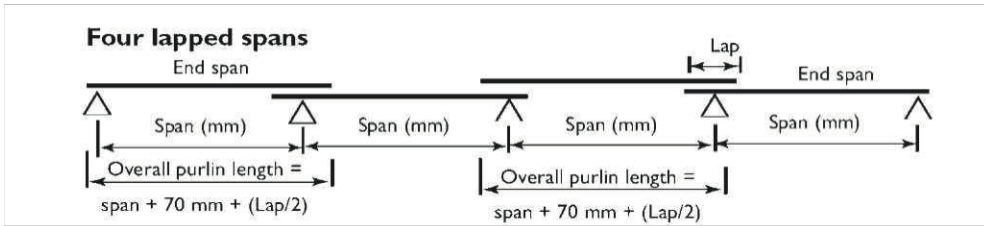

Four lapped span: C/Z 15015 (kN/m)

Bridging >	Span (mm)	IN			OUT			L/150	
		0	1	2,3	0	1	2		3
	3000	7.30	9.68	9.68	9.68	9.68	9.68	9.68	12.49
	3300	5.81	7.95	7.95	7.95	7.95	7.95	7.95	9.31
	3600	4.72	6.64	6.64	6.35	6.64	6.64	6.64	7.12
	3900	3.91	5.63	5.63	5.03	5.63	5.63	5.63	5.56
	4200	3.29	4.84	4.84	3.93	4.84	4.84	4.84	4.42
	4500	2.80	4.20	4.20	3.07	4.20	4.20	4.20	3.58
	4800	2.40	3.66	3.66	2.5	3.66	3.66	3.66	2.93
	5100	2.07	3.16	3.16	2.05	3.16	3.16	3.16	2.44
	5400	1.80	2.75	2.75	1.70	2.70	2.75	2.75	2.06
	5700	1.57	2.42	2.42	1.41	2.30	2.42	2.42	1.76
	6000	1.39	2.15	2.15	1.18	1.97	2.15	2.15	1.51
	6300	1.23	1.92	1.92	0.99	1.68	1.92	1.92	1.31
	6600	1.10	1.72	1.72	0.84	1.43	1.72	1.72	1.14
	6900	0.98	1.55	1.55	0.72	1.20	1.55	1.55	1.00
	7200	0.88	1.41	1.41	0.62	1.04	1.41	1.41	0.89
	7500	0.80	1.29	1.29	0.53	0.91	1.27	1.29	0.79
	7800	0.72	1.18	1.18	0.46	0.8	1.13	1.18	0.71
	8100	0.66	1.08	1.08	0.40	0.71	1.01	1.08	0.63
	8400	0.60	1.00	1.00		0.63	0.91	1.00	0.57
	8700	0.55	0.92	0.92		0.57	0.81	0.92	0.52
	9000	0.50	0.86	0.86		0.51	0.72	0.86	0.47
	9300	0.47	0.84	0.85		0.46	0.65	0.83	0.43
	9600	0.43	0.78	0.79		0.41	0.59	0.76	0.39
	9900	0.40	0.72	0.74			0.53	0.69	0.36

Bold capacities require grade 8.8 purlin bolts. Values above horizontal line in body of table are governed by the strength of the grade 8.8 bolt. IN = Inward load capacity. OUT = Outward load capacity L/150 = load for deflection span/150. See also: Design notes for capacity tables.

Limit state capacity tables

Four lapped spans

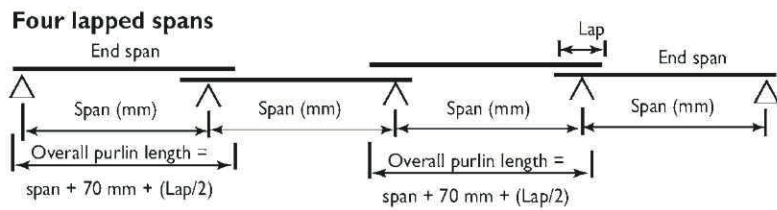

Four lapped span: Z/C 15019 (kN/m)

Four lapped span: Z/C 15024 (kN/m)

Bridging >	IN				OUT				L/150	IN				OUT				L/150
	0	1	2	3	0	1	2	3		0	1	2	3	0	1	2	3	
Span 3000	9.42	13.64	13.64	13.64	13.56	13.64	13.64	13.64	16.29	11.57	18.71	18.71	18.71	18.71	18.71	18.71	18.71	21.73
(mm) 3300	7.39	11.21	11.21	11.21	10.61	11.21	11.21	11.21	12.14	8.97	15.79	15.79	15.79	14.89	15.79	15.79	15.79	16.20
3600	5.95	9.37	9.37	9.37	8.43	9.37	9.37	9.37	9.29	7.15	13.20	13.20	13.20	11.71	13.20	13.20	13.20	12.38
3900	4.89	7.94	7.94	7.94	6.77	7.94	7.94	7.94	7.25	5.82	11.19	11.19	11.19	9.33	11.19	11.19	11.19	9.67
4200	4.09	6.82	6.82	6.82	5.39	6.82	6.82	6.82	5.77	4.83	9.61	9.61	9.61	7.38	9.61	9.61	9.61	7.70
4500	3.47	5.92	5.92	5.92	4.29	5.92	5.92	5.92	4.67	4.06	8.34	8.34	8.34	5.78	8.34	8.34	8.34	6.22
4800	2.96	5.16	5.16	5.16	3.43	5.02	5.16	5.16	3.82	3.46	7.27	7.27	7.27	4.59	7.13	7.27	7.27	5.10
5100	2.54	4.45	4.45	4.45	2.78	4.22	4.45	4.45	3.2	2.98	6.23	6.27	6.27	3.69	5.96	6.27	6.27	4.25
5400	2.21	3.88	3.88	3.88	2.29	3.59	3.88	3.88	2.71	2.59	5.37	5.47	5.47	3.01	5.04	5.47	5.47	3.58
5700	1.93	3.40	3.41	3.41	1.88	3.07	3.41	3.41	2.32	2.26	4.68	4.81	4.81	2.48	4.29	4.81	4.81	3.05
6000	1.70	2.99	3.03	3.03	1.56	2.64	3.03	3.03	2.01	2.00	4.11	4.26	4.26	2.07	3.68	4.26	4.26	2.63
6300	1.51	2.65	2.70	2.70	1.31	2.29	2.70	2.7	1.74	1.77	3.63	3.80	3.80	1.74	3.18	3.80	3.80	2.28
6600	1.34	2.37	2.43	2.43	1.10	1.97	2.39	2.43	1.53	1.58	3.23	3.42	3.42	1.48	2.75	3.40	3.42	1.97
6900	1.20	2.12	2.19	2.19	0.94	1.71	2.11	2.19	1.34	1.42	2.89	3.09	3.09	1.26	2.37	3.00	3.09	1.72
7200	1.08	1.92	1.99	1.99	0.81	1.48	1.88	1.99	1.18	1.28	2.60	2.80	2.80	1.09	2.03	2.66	2.80	1.51
7500	0.98	1.74	1.81	1.81	0.70	1.28	1.68	1.81	1.04	1.16	2.35	2.55	2.55	0.95	1.76	2.37	2.55	1.33
7800	0.88	1.58	1.66	1.66	0.61	1.12	1.51	1.66	0.93	1.05	2.14	2.34	2.34	0.83	1.53	2.11	2.34	1.18
8100	0.8	1.44	1.52	1.52	0.53	0.98	1.36	1.52	0.83	0.96	1.95	2.15	2.15	0.73	1.33	1.90	2.15	1.05
8400	0.73	1.32	1.41	1.41	0.47	0.87	1.22	1.38	0.74	0.88	1.78	1.98	1.98	0.64	1.17	1.71	1.97	0.94
8700	0.67	1.21	1.30	1.30	0.41	0.77	1.11	1.26	0.67	0.81	1.63	1.83	1.83	0.57	1.03	1.54	1.79	0.85
9000	0.61	1.12	1.21	1.21	0.36	0.68	0.99	1.15	0.61	0.74	1.50	1.70	1.70	0.51	0.92	1.39	1.63	0.76
9300	0.57	1.08	1.18	1.20	0.32	0.62	0.93	1.11	0.56	0.7	1.45	1.64	1.69	0.47	0.83	1.29	1.56	0.70
9600	0.53	1.00	1.09	1.12	0.28	0.55	0.83	1.01	0.51	0.64	1.34	1.51	1.58	0.42	0.74	1.15	1.42	0.64
9900	0.48	0.93	1.01	1.04	0.24	0.49	0.75	0.93	0.46	0.6	1.24	1.40	1.47	0.37	0.67	1.03	1.30	0.58
10200	0.45	0.86	0.94	0.98	0.20	0.44	0.67	0.85	0.42	0.55	1.15	1.30	1.37	0.33	0.6	0.92	1.19	0.53
10500	0.41	0.80	0.87	0.91	0.16	0.40	0.61	0.78	0.39	0.51	1.07	1.20	1.29	0.29	0.54	0.83	1.09	0.48
10800		0.75	0.81	0.86	0.12		0.55	0.72	0.35	0.48	1.00	1.12	1.21	0.25	0.49	0.75	1.01	0.44
SECTION BELOW EXCEED THE NORMAL DELIVERY LENGTH OF 12000 MM																		
11100		0.70	0.76	0.81	0.08		0.50	0.66	0.33	0.45	0.93	1.04	1.14	0.21	0.44	0.68	0.92	0.41
11400		0.65	0.71	0.76	0.04		0.46	0.61	0.30	0.42	0.87	0.97	1.07	0.17	0.40	0.62	0.85	0.38
11700		0.61	0.66	0.72	0.00		0.42	0.56	0.28		0.81	0.91	1.01	0.13		0.57	0.78	0.35

Bold capacities require grade 8.8 purlin bolts. Values above horizontal line in body of table are governed by the strength of the grade 8.8 bolt. IN = Inward load capacity. OUT = Outward load capacity L/150 = load for deflection span/150. See also: Design notes for capacity tables.

Limit state capacity tables

Four lapped spans

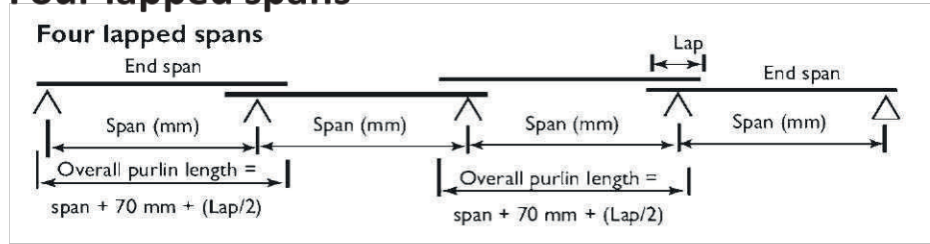

Four lapped span: C/Z 20015 (kN/m)

		IN			OUT			L/150
Bridging >		0	1,2,3	0	1	2	3	
Span	3000	10.05	10.05	10.05	10.05	10.05	10.05	24.69
(mm)	3300	8.62	8.62	8.62	8.62	8.62	8.62	18.40
	3600	6.93	7.47	7.47	7.47	7.47	7.47	14.07
	3900	5.67	6.53	6.53	6.53	6.53	6.53	10.99
	4200	4.72	5.74	5.74	5.74	5.74	5.74	8.75
	4500	3.98	5.08	5.08	5.08	5.08	5.08	7.07
	4800	3.40	4.53	4.53	4.53	4.53	4.53	5.79
	5100	2.29	4.05	3.69	4.05	4.05	4.05	4.81
	5400	2.53	3.64	3.02	3.64	3.64	3.64	4.03
	5700	2.21	3.28	2.5	3.28	3.28	3.28	3.42
	6000	1.95	2.91	2.09	2.91	2.91	2.91	2.92
	6300	1.73	2.60	1.76	2.60	2.60	2.60	2.51
	6600	1.54	2.33	1.50	2.33	2.33	2.33	2.18
	6900	1.38	2.11	1.28	2.11	2.11	2.11	1.91
	7200	1.24	1.91	1.07	1.89	1.91	1.91	1.70
	7500	1.13	1.74	0.93	1.67	1.74	1.74	1.53
	7800	1.02	1.60	0.82	1.48	1.60	1.60	1.37
	8100	0.93	1.47	0.72	1.30	1.47	1.47	1.24
	8400	0.85	1.35	0.64	1.14	1.35	1.35	1.12
	8700	0.78	1.25	0.57	1.01	1.25	1.25	1.02
	9000	0.71	1.16	0.51	0.9	1.16	1.16	0.93
	9300	0.65	1.16	0.47	0.83	1.16	1.16	0.86
	9600	0.60	1.08	0.42	0.74	1.06	1.08	0.78
	9900	0.56	1.00		0.67	0.97	1.00	0.71
	10200	0.51	0.94		0.60	0.89	0.94	0.65
	10500	0.48	0.88		0.54	0.81	0.88	0.60
	10800	0.45	0.82		0.47	0.73	0.82	0.55
SECTION BELOW EXCEED THE NORMAL DELIVERY LENGTH OF 12000 MM								
	11100	0.42	0.78		0.43	0.66	0.78	0.51
	11400		0.73			0.61	0.73	0.47
	11700		0.69			0.55	0.69	0.44
	12000		0.65			0.51	0.65	0.41

Bold capacities require grade 8.8 purlin bolts. Values above horizontal line in body of table are governed by the strength of the grade 8.8 bolt. IN = Inward load capacity. OUT = Outward load capacity L/150 = load for deflection span/150. See also: Design notes for capacity tables.

Limit state capacity tables

Four lapped spans

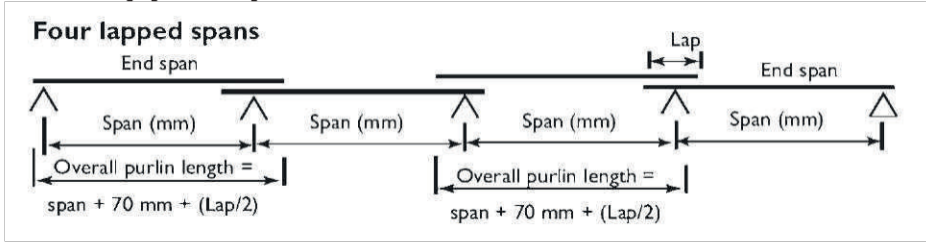

Four lapped span: C/Z 20019 (kN/m)

Four lapped span: C/Z 20024 (kN/m)

Four lapped span: C/Z 25019 (kN/m)

Bridging > (mm)	IN			OUT			L/150	IN			OUT			L/150	IN			OUT			L/150		
	0	1	2,3	0	1	2		3	0	1	2	3	0		1	2	3	0	1	2,3		0	1
3000	14.21	18.71	18.71	18.71	18.71	18.71	18.71	18.71	18.71	18.71	18.71	18.71	18.71	46.45	16.52	16.52	16.52	16.52	16.52	16.52	16.52	16.52	57.13
3300	11.11	16.18	16.18	16.38	16.18	16.18	16.18	16.18	16.18	16.18	16.18	16.18	16.18	34.62	14.29	14.29	14.29	14.29	14.29	14.29	14.29	14.29	42.58
3600	8.92	13.72	13.72	13.72	13.72	13.72	13.72	13.72	13.72	13.72	13.72	13.72	13.72	26.47	11.46	12.49	12.49	12.49	12.49	12.49	12.49	12.49	32.56
3900	7.31	11.63	11.63	11.63	11.63	11.63	11.63	11.63	11.63	11.63	11.63	11.63	11.63	20.68	9.36	11.01	11.01	11.01	11.01	11.01	11.01	11.01	25.43
4200	6.09	9.99	9.99	9.77	9.99	9.99	9.99	9.99	9.99	9.99	9.99	9.99	9.99	16.45	7.75	9.78	9.78	9.78	9.78	9.78	9.78	9.78	20.24
4500	5.13	8.66	8.66	8.01	8.66	8.66	8.66	8.66	8.66	8.66	8.66	8.66	8.66	13.30	6.48	8.73	8.73	8.73	8.73	8.73	8.73	8.73	1.36
4800	4.36	7.56	7.56	6.48	7.56	7.56	7.56	7.56	7.56	7.56	7.56	7.56	7.56	10.90	5.50	7.84	7.84	7.84	7.84	7.84	7.84	7.84	13.41
5100	3.73	6.52	6.52	5.10	6.52	6.52	6.52	6.52	6.52	6.52	6.52	6.52	6.52	9.05	4.70	7.07	7.07	7.07	7.07	7.07	7.07	7.07	11.13
5400	3.27	5.68	5.68	4.22	5.68	5.68	5.68	5.68	5.68	5.68	5.68	5.68	5.68	7.59	4.07	6.40	6.40	6.40	6.40	6.40	6.40	6.40	3.33
5700	2.82	5.00	5.00	3.53	5.00	5.00	5.00	5.00	5.00	5.00	5.00	5.00	5.00	6.43	3.55	5.82	5.82	5.82	5.82	5.82	5.82	5.82	7.90
6000	2.48	4.43	4.43	2.99	4.43	4.43	4.43	4.43	4.43	4.43	4.43	4.43	4.43	5.49	3.12	5.31	5.31	5.31	5.31	5.31	5.31	5.31	6.75
6300	2.20	3.95	3.95	2.55	3.95	3.95	3.95	3.95	3.95	3.95	3.95	3.95	3.95	4.73	2.76	4.86	4.86	4.86	4.86	4.86	4.86	4.86	5.81
6600	1.96	3.55	3.55	2.19	3.55	3.55	3.55	3.55	3.55	3.55	3.55	3.55	3.55	4.14	2.46	4.46	4.46	4.46	4.46	4.46	4.46	4.46	5.04
6900	1.75	3.21	3.21	1.88	3.21	3.21	3.21	3.21	3.21	3.21	3.21	3.21	3.21	3.65	2.20	4.07	4.07	4.07	4.07	4.07	4.07	4.07	4.40
7200	1.58	2.91	2.91	1.62	2.91	2.91	2.91	2.91	2.91	2.91	2.91	2.91	2.91	3.23	1.98	3.70	3.70	3.70	3.70	3.70	3.70	3.70	3.86
7500	1.43	2.65	2.65	1.40	2.65	2.65	2.65	2.65	2.65	2.65	2.65	2.65	2.65	2.87	1.79	3.37	3.37	3.37	3.37	3.37	3.37	3.37	3.40
7800	1.30	2.43	2.43	1.22	2.43	2.43	2.43	2.43	2.43	2.43	2.43	2.43	2.43	2.57	1.63	3.08	3.08	3.08	3.08	3.08	3.08	3.08	3.02
8100	1.18	2.23	2.23	1.07	2.23	2.23	2.23	2.23	2.23	2.23	2.23	2.23	2.23	2.31	1.48	2.83	2.83	2.83	2.83	2.83	2.83	2.83	2.71
8400	1.08	2.06	2.06	0.94	2.06	2.06	2.06	2.06	2.06	2.06	2.06	2.06	2.06	2.07	1.36	2.61	2.61	2.61	2.61	2.61	2.61	2.61	2.65
8700	0.99	1.91	1.91	0.83	1.91	1.91	1.91	1.91	1.91	1.91	1.91	1.91	1.91	1.86	1.24	2.42	2.42	2.42	2.42	2.42	2.42	2.42	2.23
9000	0.91	1.77	1.77	0.73	1.77	1.77	1.77	1.77	1.77	1.77	1.77	1.77	1.77	1.68	1.14	2.24	2.24	2.24	2.24	2.24	2.24	2.24	2.04
9300	0.86	1.73	1.73	0.67	1.73	1.73	1.73	1.73	1.73	1.73	1.73	1.73	1.73	1.55	1.07	2.23	2.23	2.23	2.23	2.23	2.23	2.23	1.88
9600	0.79	1.59	1.59	0.59	1.59	1.59	1.59	1.59	1.59	1.59	1.59	1.59	1.59	1.41	0.99	2.08	2.08	2.08	2.08	2.08	2.08	2.08	1.72
9900	0.73	1.48	1.48	0.53	1.48	1.48	1.48	1.48	1.48	1.48	1.48	1.48	1.48	1.29	0.92	1.94	1.94	1.94	1.94	1.94	1.94	1.94	1.58
10200	0.68	1.37	1.37	0.47	1.37	1.37	1.37	1.37	1.37	1.37	1.37	1.37	1.37	1.18	0.85	1.81	1.81	1.81	1.81	1.81	1.81	1.81	1.46
10500	0.63	1.27	1.27	0.43	1.27	1.27	1.27	1.27	1.27	1.27	1.27	1.27	1.27	1.08	0.79	1.68	1.70	1.70	1.70	1.70	1.70	1.70	1.34
10800	0.59	1.19	1.19	0.39	1.19	1.19	1.19	1.19	1.19	1.19	1.19	1.19	1.19	1.00	0.74	1.57	1.59	1.59	1.59	1.59	1.59	1.59	1.23
SECTION BELOW EXCEED THE NORMAL DELIVERY LENGTH OF 12000 MM																							
11100	0.55	1.11	1.11	0.35	1.11	1.11	1.11	1.11	1.11	1.11	1.11	1.11	1.11	0.92	0.69	1.46	1.50	1.50	1.50	1.50	1.50	1.50	1.14
11400	0.52	1.04	1.04	0.31	1.04	1.04	1.04	1.04	1.04	1.04	1.04	1.04	1.04	0.85	0.64	1.36	1.41	1.41	1.41	1.41	1.41	1.41	1.05
11700	0.48	0.97	0.97	0.27	0.97	0.97	0.97	0.97	0.97	0.97	0.97	0.97	0.97	0.78	0.60	1.27	1.33	1.33	1.33	1.33	1.33	1.33	0.97
12000	0.45	0.91	0.91	0.24	0.91	0.91	0.91	0.91	0.91	0.91	0.91	0.91	0.91	0.73	0.56	1.18	1.26	1.26	1.26	1.26	1.26	1.26	0.91

Bold capacities require grade 8.8 purlin bolts. Values above horizontal line in body of table are governed by the strength of the grade 8.8 bolt. IN = Inward load capacity. OUT = Outward load capacity L/150 = load for deflection span/150. See also: Design notes for capacity tables.

Limit state capacity tables

Four lapped spans

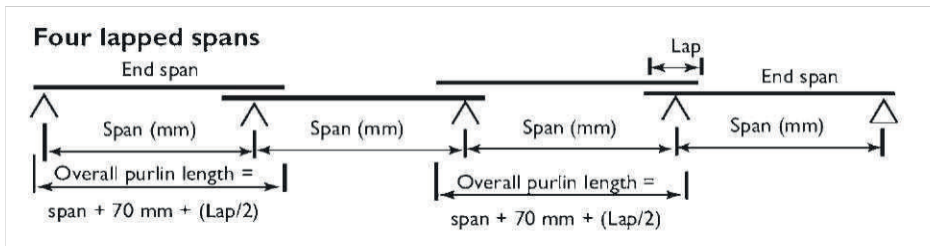

Four lapped span: C/Z 25024 (kN/m)

IN				OUT				L/150
0	1	2	3	0	1	2	3	
18.71	18.71	18.71	18.71	18.71	18.71	18.71	18.71	78.8
17.04	17.04	17.04	17.04	17.04	17.04	17.04	17.04	58.73
14.20	15.65	15.65	15.65	15.65	15.65	15.65	15.65	44.90
11.35	14.47	14.47	14.47	14.47	14.47	14.47	14.47	35.08
9.27	13.45	13.45	13.45	13.45	13.45	13.45	13.45	27.91
7.70	12.57	12.57	12.57	12.57	12.57	12.57	12.57	22.56
6.48	11.80	11.80	11.80	11.80	11.80	11.80	11.80	18.5
5.53	11.12	11.12	11.12	9.68	11.12	11.12	11.12	15.35
4.76	10.51	10.51	10.51	7.80	10.51	10.51	10.51	12.87
4.14	9.31	9.31	9.31	6.53	9.31	9.31	9.31	10.90
3.63	8.26	8.26	8.26	5.47	8.26	8.26	8.26	9.31
3.21	7.37	7.37	7.37	4.60	7.37	7.37	7.37	8.01
2.86	6.62	6.62	6.62	3.87	6.49	6.62	6.62	6.95
2.56	5.97	5.98	5.98	3.28	5.72	5.98	5.98	6.06
2.30	5.36	5.42	5.42	2.80	5.05	5.42	5.42	5.32
2.08	4.84	4.95	4.95	2.41	4.48	4.95	4.95	4.70
1.89	2.39	4.53	4.53	2.09	3.95	4.53	4.53	4.19
1.72	4.00	4.16	4.16	1.82	3.48	4.16	4.16	3.75
1.57	3.66	3.84	3.84	1.59	3.07	3.84	3.84	3.38
1.44	3.36	3.55	3.55	1.40	2.71	3.55	3.55	3.06
1.33	3.09	3.29	3.29	1.23	2.41	3.26	3.29	2.77
1.23	2.97	3.28	3.28	1.12	2.22	3.13	3.28	2.55
1.14	2.74	3.05	3.05	1.00	1.99	2.85	3.05	2.33
1.06	2.53	2.85	2.85	0.89	1.78	2.61	2.85	2.13
0.98	2.34	2.66	2.66	0.80	1.59	2.38	2.66	1.96
0.91	2.17	2.49	2.49	0.72	1.43	2.17	2.49	1.80
0.85	2.02	2.34	2.34	0.65	1.28	1.97	2.34	1.65
SECTION BELOW EXCEED THE NORMAL DELIVERY LENGTH OF 12000 MM								
0.80	1.88	2.20	2.20	0.59	1.16	1.79	2.18	1.52
0.74	1.75	2.07	2.08	0.53	1.05	1.63	2.02	1.40
0.70	1.64	1.94	1.96	0.49	0.95	1.49	1.88	1.30
0.65	1.53	1.82	1.85	0.44	0.87	1.36	1.75	1.20

Bold capacities require grade 8.8 purlin bolts. Values above horizontal line in body of table are governed by the strength of the grade 8.8 bolt. IN = Inward load capacity. OUT = Outward load capacity L/150 = load for deflection span/150. See also: Design notes for capacity tables.

Limit state capacity tables

Four lapped spans

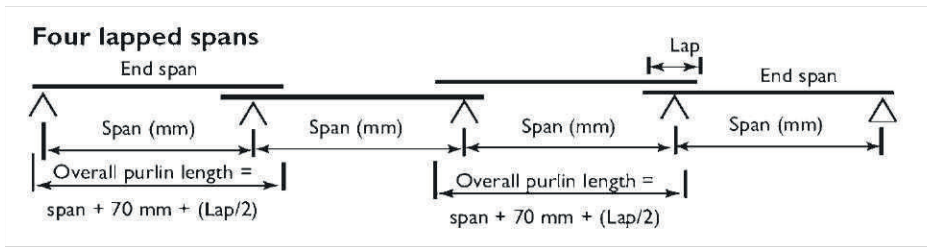

Bridging > Span mm	Four lapped span: C/Z 30024 (kN/m)									Four lapped span: C/Z 30024/30030 (kN/m)								
	INWARD				OUTWARD				L/150	INWARD				OUTWARD				L/150
	0	1	2	3	0	1	2	3		0	1	2	3	0	1	2	3	
6000	5.40	9.68	9.68	9.68	9.68	9.68	9.68	9.68	15.45	5.84	10.24	10.24	10.24	10.24	10.24	10.24	10.24	20.01
6300	4.73	8.90	8.90	8.90	8.86	8.90	8.90	8.90	13.3	5.10	9.38	9.38	9.38	9.38	9.38	9.38	9.38	17.23
6600	4.17	8.21	8.21	8.21	7.55	8.21	8.21	8.21	11.53	4.49	8.62	8.62	8.62	8.62	8.62	8.62	8.62	14.94
6900	3.70	7.59	7.59	7.59	6.39	7.59	7.59	7.59	10.06	3.98	7.94	7.94	7.94	7.69	7.94	7.94	7.94	13.03
7200	3.31	7.03	7.03	7.03	5.57	7.03	7.03	7.03	8.83	3.55	7.34	7.34	7.34	6.66	7.34	7.34	7.34	11.44
7500	2.98	6.53	6.53	6.53	4.89	6.53	6.53	6.53	7.79	3.19	6.80	6.80	6.80	5.80	6.80	6.80	6.80	10.09
7800	2.69	6.08	6.08	6.08	4.32	6.08	6.08	6.08	6.91	2.88	6.32	6.32	6.32	5.00	6.32	6.32	6.32	8.95
8100	2.44	5.68	5.68	5.68	3.83	5.68	5.68	5.68	6.16	2.61	5.87	5.87	5.87	4.44	5.87	5.87	5.87	7.98
8400	2.22	5.27	5.27	5.27	3.38	5.27	5.27	5.27	5.51	2.37	5.41	5.41	5.41	3.96	5.41	5.41	5.41	7.14
8700	2.03	4.87	4.87	4.87	2.99	4.87	4.87	4.87	4.95	2.17	5.01	5.01	5.01	3.54	5.01	5.01	5.01	6.46
9000	1.86	4.52	4.52	4.52	2.67	4.49	4.52	4.52	4.46	1.99	4.64	4.64	4.64	3.19	4.64	4.64	4.64	5.87
9300	1.73	4.40	4.51	4.51	2.43	4.27	4.51	4.51	4.11	1.84	4.63	4.63	4.63	2.98	4.63	4.63	4.63	5.4
9600	1.60	4.05	4.19	4.19	2.15	3.86	4.19	4.19	3.76	1.70	4.31	4.31	4.31	2.67	4.31	4.31	4.31	4.94
9900	1.48	3.74	3.91	3.91	1.92	3.48	3.91	3.91	3.46	1.57	4.01	4.02	4.02	2.40	4.01	4.02	4.02	4.53
10200	1.37	3.46	3.65	3.65	1.72	3.14	3.65	3.65	3.19	1.46	3.71	3.76	3.76	2.16	3.67	3.76	3.76	4.16
10500	1.28	3.21	3.45	3.45	1.54	2.84	3.45	3.45	2.95	1.36	3.44	3.52	3.52	1.94	3.36	3.52	3.52	3.83
10800	1.19	2.98	3.21	3.21	1.39	2.53	3.21	3.21	2.72	1.27	3.20	3.30	3.30	1.75	3.09	3.30	3.30	3.54

SECTION BELOW EXCEED THE NORMAL DELIVERY LENGTH OF 12000 MM

11100	1.11	2.76	3.02	3.02	1.25	2.32	3.02	3.02	2.51	1.18	2.98	3.11	3.11	1.59	2.82	3.11	3.11	3.27
11400	1.04	2.57	2.85	2.85	1.13	2.13	2.85	2.85	2.33	1.11	2.78	2.93	2.93	1.44	2.58	2.93	2.93	3.02
11700	0.98	2.40	2.69	2.69	1.03	1.96	2.69	2.69	2.15	1.04	2.61	2.76	2.76	1.31	2.36	2.76	2.76	2.80
12000	0.92	2.24	2.54	2.54	0.94	1.81	2.54	2.54	2.00	0.97	2.44	2.61	2.61	1.20	2.17	2.61	2.61	2.60
12300	0.87	2.18	2.68	2.68	0.89	1.78	2.53	2.68	1.90	0.93	2.38	2.75	2.75	1.13	2.08	2.75	2.75	2.47
12600	0.82	2.00	2.53	2.53	0.81	1.63	2.35	2.53	1.77	0.87	2.23	2.60	2.60	1.04	1.93	2.60	2.60	2.30
12900	0.77	1.88	2.40	2.40	0.74	1.50	2.16	2.40	1.65	0.82	2.09	2.47	2.47	0.95	1.79	2.47	2.47	2.15
13200	0.73	1.77	2.27	2.27	0.68	1.38	2.00	2.27	1.54	0.78	1.96	2.34	2.34	0.88	1.66	2.33	2.34	2.01
13500	0.69	1.67	2.16	2.16	0.63	1.28	1.85	2.16	1.44	0.74	1.85	2.22	2.22	0.81	1.54	2.18	2.22	1.88
13800	0.66	1.58	2.05	2.05	0.58	1.18	1.72	2.05	1.35	0.70	1.74	2.11	2.11	0.75	1.44	2.04	2.11	1.76
14100	0.62	1.49	1.95	1.95	0.53	1.09	1.59	1.95	1.27	0.66	1.64	2.01	2.01	0.69	1.34	1.91	2.01	1.65
14400	0.59	1.41	1.85	1.86	0.49	1.00	1.46	1.86	1.20	0.63	1.55	1.92	1.92	0.64	1.25	1.79	1.92	1.54
14700	0.56	1.34	1.75	1.78	0.46	0.93	1.36	1.76	1.13	0.6	1.44	1.83	1.83	0.59	1.16	1.67	1.83	1.45
15000	0.53	1.27	1.66	1.70	0.42	0.86	1.28	1.66	1.06	0.57	1.37	1.75	1.75	0.55	1.08	1.56	1.75	1.36
15300	0.51	1.21	1.57	1.62		0.80	1.20	1.57	1.01	0.54	1.30	1.67	1.67	0.52	1.01	1.46	1.67	1.28
15600	0.48	1.15	1.49	1.56		0.74	1.13	1.48	0.95	0.51	1.24	1.60	1.60	0.48	0.95	1.36	1.60	1.21
15900	0.46	1.09	1.42	1.49		0.69	1.06	1.39	0.90	0.49	1.18	1.53	1.53	0.45	0.88	1.28	1.53	1.14
16200	0.44	1.04	1.35	1.43		0.64	1.00	1.31	0.86	0.47	1.12	1.46	1.47	0.42	0.82	1.20	1.46	1.08
16500	0.42	0.99	1.29	1.37		0.60	0.94	1.23	0.81	0.45	1.07	1.39	1.41		0.77	1.11	1.39	1.02
16800	0.40	0.95	1.22	1.32		0.56	0.89	1.16	0.77	0.43	1.02	1.33	1.35		0.72	1.05	1.33	0.96
17100		0.91	1.16	1.27		0.52	0.84	1.09	0.74	0.41	0.98	1.27	1.30		0.67	0.99	1.27	0.91
17400		0.87	1.11	1.22		0.49	0.79	1.03	0.70		0.93	1.21	1.25		0.63	0.94	1.21	0.87

Bold capacities require grade 8.8 purlin bolts. Values above horizontal line in body of table are governed by the strength of the grade 8.8 bolt. IN = Inward load capacity. OUT = Outward load capacity L/150 = load for deflection span/150. See also: Design notes for capacity tables.

Limit state capacity tables

Four lapped spans

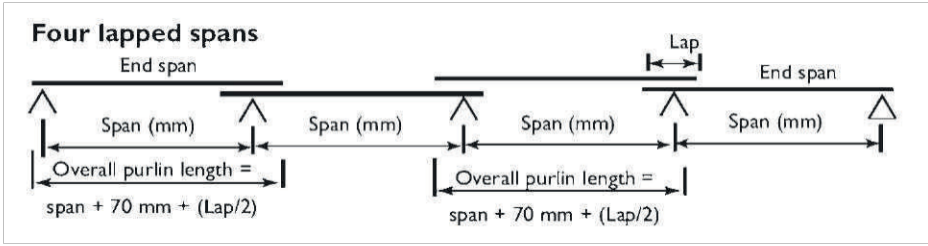

Section	Cantilever 1000 mm (kN/m)								Cantilever 2000 mm (kN/m)						Cantilever 3000 mm (kN/m)								
	End-span [mm]	IN bridging			OUT bridging			L/150	IN bridging			OUT bridging			L/150	IN bridging			OUT bridging			L/150	
		0	1	2	0	1	2		0	1	2	0	1	2		0	1	2	0	1	2		
Z/C	2000	9.69	9.69	9.69	9.69	9.69	9.69	7.18															
10019	4000	2.41	2.76	2.76	1.41	2.41	2.76	0.48	1.94	2.41	2.42	2.13	2.42	2.42	0.90	0.62	0.86	0.95	1.08	1.08	1.08	0.13	
	6000	0.96	1.14	1.14	0.34	0.60	0.95	0.12	1.01	1.36	1.36	0.42	0.74	1.15	0.22	0.58	0.79	0.88	0.65	0.95	1.08	0.27	
Z/C	2000	11.11	1.11	11.1	11.11	11.11	11.11	15.12															
15015	4000	3.37	3.49	3.49	2.48	3.49	3.49	1.14	2.87	3.06	3.06	3.06	3.06	3.06	2.09	1.00	1.36	1.36	1.36	1.36	1.36	0.32	
	6000	1.33	1.44	1.44	0.59	1.06	1.44	0.27	1.40	1.72	1.72	0.73	1.28	1.72	0.52	0.91	1.28	1.36	1.00	1.36	1.36	0.63	
	8000	0.71	0.79	0.79	0.2	0.41	0.64	0.11	0.72	0.87	0.87	0.22	0.45	0.71	0.14	0.68	1.04	1.04	0.29	0.56	0.87	0.36	
Z/C	2000	16.64	16.6	117	16.6	16.64	16.60	19.82															
15019	4000	4.24	4.92	4.92	3.46	4.92	4.92	1.43	3.74	4.32	4.32	4.25	4.32	4.32	2.68	1.44	1.80	1.91	1.92	1.92	1.92	0.40	
	6000	1.64	2.04	2.04	0.78	1.50	1.98	0.34	1.74	2.42	2.42	0.95	1.83	2.38	0.65	1.23	1.71	1.82	1.43	1.90	1.92	0.80	
	8000	0.86	1.10	1.11	0.28	0.54	0.88	0.14	0.88	1.21	1.23	0.30	0.59	0.98	0.18	0.86	1.36	1.45	0.39	0.74	1.20	0.45	
Z/C	2000	23.04	23.00	23.00	23.00	23.04	23.00	26.35															
15024	4000	5.43	6.93	6.93	4.68	6.93	6.93	1.80	5.02	6.09	6.09	6.02	6.09	6.09	3.38	2.00	2.55	2.71	2.71	2.71	2.71	0.50	
	6000	1.98	2.86	2.87	1.06	2.06	2.82	0.43	2.06	3.37	3.41	1.29	2.25	3.38	0.82	1.61	2.40	2.57	1.96	2.70	2.70	1.00	
	8000	1.01	1.48	1.57	0.39	0.72	1.23	0.17	1.03	1.62	1.73	0.43	0.80	1.37	0.23	1.01	1.84	2.06	0.54	1.00	1.67	0.57	
Z/C	4000	4.73	4.73	4.73	4.53	4.73	4.73	2.44	3.93	3.93	3.93	3.93	3.93	3.93	4.14	1.80	1.85	1.85	1.85	1.85	1.85	0.70	
20015	6000	1.88	1.96	1.96	1.06	1.93	1.96	0.60	2.01	2.33	2.33	1.29	2.32	2.33	1.12	1.50	1.85	1.85	1.80	1.85	1.85	1.29	
	8000	0.98	1.07	1.07	0.40	0.74	1.07	0.24	1.01	1.18	1.18	0.44	0.81	1.18	0.31	1.00	1.41	1.41	0.55	1.01	1.41	0.76	
Z/C	4000	6.53	7.20	7.20	6.55	7.20	7.20	3.21	6.04	6.33	6.33	6.33	6.33	6.33	5.59	2.61	2.81	2.81	2.81	2.81	2.81	0.90	
20019	6000	2.30	2.98	2.98	1.66	2.82	2.98	0.77	2.46	3.54	3.54	1.94	3.39	3.54	1.47	2.01	2.81	2.81	2.59	2.81	2.81	1.75	
	8000	1.19	1.63	1.63	0.56	1.07	1.61	0.30	1.24	1.80	1.80	0.62	1.18	1.79	0.40	1.29	2.14	2.14	0.78	1.45	2.14	1.01	
Z/C	4000	8.48	10.5	10.5	9.12	10.47	10.5	4.06	8.05	9.20	9.20	9.20	9.20	9.20	7.47	7.47	3.62	4.09	4.09	4.09	4.09	1.13	
20024	6000	2.97	4.34	4.34	2.18	3.89	4.34	0.97	3.16	5.15	5.15	2.63	4.67	5.51	1.85	2.73	4.04	4.09	3.59	4.09	4.09	2.25	
	8000	1.50	2.25	2.25	0.76	1.53	2.21	0.38	1.53	2.47	2.62	0.83	1.68	2.44	0.51	1.54	2.89	3.11	1.04	2.08	2.95	1.28	
Z/C	4000	8.50	9.14	9.14	8.72	9.14	9.14	5.35	6.98	6.98	6.98	6.98	6.98	6.98	9.14	3.47	3.57	3.57	3.57	3.57	3.57	1.52	
25019	6000	3.00	3.79	3.79	2.09	3.77	2.79	1.30	3.16	4.31	4.31	2.39	4.31	4.31	2.02	2.61	3.57	3.57	3.44	3.57	3.57	2.88	
	8000	1.53	2.07	2.07	0.72	1.41	2.07	0.51	1.59	2.28	2.28	0.79	1.55	2.28	0.68	1.63	2.72	2.72	0.99	1.91	2.72	1.66	
	10000	0.93	1.31	1.31	0.31	0.64	1.03	0.26	0.95	1.39	1.39	0.33	0.68	1.10	0.30	0.97	1.55	1.55	0.37	0.77	1.24	0.44	
Z/C	4000	10.86	13.4	13.4	12.1	13.41	13.4	6.86	10.5	11.46	11.5	11.46	11.46	11.46	12.35	4.79	5.24	5.24	5.24	5.24	5.24	1.92	
25024	6000	3.77	5.56	5.56	2.85	5.19	5.56	1.64	3.94	6.33	6.33	3.21	5.95	6.33	2.56	3.46	5.24	5.24	4.75	5.24	5.24	3.80	
	8000	1.87	2.99	3.04	0.96	1.98	2.95	0.65	1.91	3.28	3.35	1.04	2.18	3.27	0.86	1.92	3.83	3.99	1.31	2.70	3.94	2.16	
	10000	1.11	1.80	1.93	0.42	0.86	1.48	0.32	1.11	1.90	2.05	0.44	0.91	1.58	0.38	1.12	2.10	2.28	0.50	1.03	1.79	0.55	

Bold capacities require grade 8.8 purlin bolts. Values above horizontal line in body of table are governed by the strength of the grade 8.8 bolt. IN = Inward load capacity. OUT = Outward load capacity L/150 = load for deflection span/150. See also: Design notes for capacity tables.